

# CLUSTER **B4 W**



USER MANUAL

## CONTENT

### 1. Safety Informations

1.1. General Preventive Measures	4
1.2. Regulations for equipment that connects to power mains	5
1.3. Technical warnsigns and explanation	6

### 2. Introduction

2.1. About us	7
2.2. CLUSTER B4 W	7

### 3. General Product Information

3.1. Scope of delivery	8
3.2. Control Functions	8
3.3. Features	8

### 4. Installation & Setup

4.1 Physical Installation and Rigging	9
4.2 Connections	14
4.2.1. AC Power	15
4.2.2. DMX Connection	15
4.2.2.1. Cable Connection	15

### 5. Operation

5.1 Start up	16
5.2 Control Display	16
5.3 Display Short Cuts	16
5.4 Configuration	18
5.4.1 Set DMX Start Address (Direct Access)	18
5.4.2 Selecting DMX Mode	18
5.4.3 Stand Alone	19
5.4.4 Slave Mode	21
5.4.5 Settings	21
5.4.6 System Info	25

### 6. Accessories

6.1 Accessories	26
-----------------	----

---

## **7. Technical Data / Diagrams**

---

7.1 Technical drawings and measurements	27
7.2 IP Rating	28
7.3 Technical Data	29
7.4 DMX-Charts	31
7.5 RDM Templates	39

---

## **8. Troubleshooting**

---

41

## **9. Manufacturer's Declaration**

---

42

## 1. SAFETY INFORMATION

### 1.1. General Preventive Measures

- 1.1.1. Please read, understand and follow the instructions.
- 1.1.2. Store the instructions and information in a safe place.  
Best solution is the ring binder provided by ROXX.
- 1.1.3. Follow all safety warnings. Under no circumstances remove safety warnings or other information from the equipment.
- 1.1.4. Don't use the equipment for any other intended purpose or manner.
- 1.1.5. Use only stable and compatible stands and/or brackets. Especially when fix installed. Make sure the wall brackets are properly installed and safe. Make sure the device is securely installed and cannot fall.
- 1.1.6. Check the safety regulations applying for your country before and during installation.
- 1.1.7. Keep the device away from heat! Don't place/install near heaters, ovens or any source of heat. Make sure that the device always is efficiently cooled and cannot overheat.
- 1.1.8. Always guarantee that ventilation and cooling slots are clean and not blocked.
- 1.1.9. Item must be away minimum 20cm from anything around and above it.
- 1.1.10. Do not use this device close to water.
- 1.1.11. Do not expose this equipment to flammable materials.
- 1.1.12. Make sure that no objects can fall into the device.
- 1.1.13. Only use this device with the accessories recommended by the manufacturer.
- 1.1.14. Always check the equipment for housing damages, so that no water can enter the device. No containers containing liquids of any kind should be place on top of the unit.
- 1.1.15. Opening or modifying this device is only allowed by authorized and qualified persons.
- 1.1.16. All cables need to be checked after connecting the device in order to prevent damage or accidents.
- 1.1.17. Make sure that the device is transported safe and packed proper in order to prevent damage of any kind.
- 1.1.18. Once you notice improper function of your device due to damage, electric shock or anything similar, immediately unplug the unit from the mains outlet and contact our service department.
- 1.1.19. Clean the device with a dry cloth.

- 1.1.20. Observe all disposal laws applicable in your country. Especially for the packaging.
- 1.1.21. Plastic bags are not a toy! Keep away from children!
- 1.1.22. Please note that changes or modifications which are not approved by the party responsible for compliance will void the user's authority to operate the device.

## **1.2 Regulations for equipment that connects to power mains**

- 1.2.1. If an earthing contact is available in the used power cord, it must be used in combination with a power outlet, providing a protective ground. In no circumstances should the protective ground be deactivated.
- 1.2.2. Do not switch on the device immediately after it has been in strong different temperatures, especially after transport. Let the device acclimatize to the temperature in the room of usage first to prevent moisture and condensation.
- 1.2.3. Verify that the correct voltage and frequency are available in the area of operation, before connecting the unit to the mains outlet.
- 1.2.4. If the plug doesn't fit in your mains outlet, contact your electrician.
- 1.2.5. Make sure your power cord/adaptor/connector does not show signs of kinks/warps or is being stepped on.
- 1.2.6. Always disconnect the unit when not in use or being cleaned. Don't pull on the cord to disconnect. Only touch power connections with dry hands!
- 1.2.7. Don't switch the unit on/off rapidly. This may cause damage.
- 1.2.8. If a fuse needs to be replaced, ALWAYS make sure that exactly the same fuse will be used (type and rating). Repeatedly blown fuses need to be checked by an authorized service technician.
- 1.2.9. In the risk of lightning strike all units need to be unplugged from the mains in order to prevent damage.
- 1.2.10. During installation there must be a voltage free condition.
- 1.2.11. The device needs to be cleaned and serviced regularly and will credit this with a longer life cycle. Dust, dirt, moist, water, smoke, nicotine or anything similar inside the unit will cause damage/malfunction.
- 1.2.12. The unit needs to have at least 0,5m distance to anything flammable.
- 1.2.13. You have to make sure that any electrical installation applies to the laws of your country. Correct power cables and applying standards have to be used.

### 1.3. Technical warnsigns and explanation



In order to prevent the risk of an electric shock, under no circumstances remove the cover/back or open the unit in any way! No user serviceable parts are inside. Service, maintenance and repairs should only be done by qualified service personnel or the manufacturer.



Dangerous uninsulated voltage inside the device can cause an electrical shock when opened by unqualified personnel.



Important operating and maintenance instructions apply!



Do not operate this device in tropical climates.



CAUTION! Intense LED light source! Risk of eye damage. Do not look into the light source



The housing surface of the spotlight can heat up to temperatures as high as 70 °C in regular use. Ensure that it is not possible to come into contact with the housing unintentionally. Always allow sufficient time for the lamp to cool down before dismantling, carrying out maintenance work or charging etc..



#### IMPORTANT INFORMATION!

- This is a product which has been developed for professional usage in event technology. It is not suitable as a household lighting.
- NEVER stare, not even temporarily, directly into the light source.
- Don't use magnifiers or any other optical instrument to look at the beam.
- The effects of this device, especially the stroboscope effect, can cause problems for sensitive people or may even cause epileptical seizures.

## 2. INTRODUCTION

### 2.1. About us

*The name ROXX® came easily.*

Combined with the concentrated knowledge and many years of experience, our three founders, who have been leaving their mark in the event and lighting industry for many years already, came together in 2020 to start this outstanding venture.

Product development, sales and marketing as well as the exceptional know-how and the profound rooting in the field of the professional lighting technology belong to our core competences and therefore guarantee extremely innovative and reliable products, excellent support and professional service in every aspect.

*Designed & developed in Germany*

ROXX® products are developed and designed in Germany. Always in tight consultation with our customers and experts who will eventually be working with these tools. This ensures innovative, easy-to-use and performance-oriented solutions, which provide added value for our customers.

*Made to last*

Recommended for permanent outdoor use, most ROXX® products feature additional corrosion protection and enhanced IP66 equipment protection, thereby providing that crucial extra for a wider range of applications. In addition to architectural or theme park applications, even fixed installations in coastal or offshore areas with high salt exposure can be reliably implemented over long periods of time.

### 2.2. CLUSTER B4 W

All CLUSTER products can be easily connected both horizontal and vertically, by using the integrated C-Lok system. The series is made to enable toolless multiple array configurations, scalable from a single vertical line, to massive matrix like arrays. Due IP65 rating all products are outdoor ready and protected from ingress of dust and rain. There are several mounting options – Camlock mounts on top and back enable the use of Omega-Brackets, Yokes can be attached to mounting points on all sides, or the internal C-Lok system can be used for seamless interconnection. Pre-Link Magnets on top and side help to align the fixtures, giving an incredible user-friendly operation and save interlocking. A specially designed rigging bracket is used for seamless connection of multiple Blinders, to avoid gaps due to bracing of the truss structure by variable, sliding mounting positions. Floor extensions can be used to create vertical structures in single or double rows.

In the warmwhite versions, an emulated 'shift to warm' warms the color temperature of the light as it dims. To deliver a perfect classic tungsten look, Amber and Red LED's are mixed with the highpower warmwhite LED's when decaying.

## 3. GENERAL PRODUCT INFORMATION

### 3.1. Scope of delivery

- ⊖ 1x CLUSTER B4 W
- ⊖ Power cord with plug (EU country specific, if not ordered differently)
- ⊖ Pre-installed PUK

We're offering a wide range of professional accessories (optional). Please see under menu 6 or at our website [www.roxxlight.com](http://www.roxxlight.com)

### 3.2. Control Functions

- 1CH DWE, 2CH DWE, 4-1CH DWE, 4-2CH DWE, 7CH STROBE, 9CH STANDARD, 12CH EXTENDED, 17CH EXTENDED
- RDM (Remote Device Management)
- Stand Alone Functions including auto programs and Quick Light.
- Master & Slave

### 3.3. Features

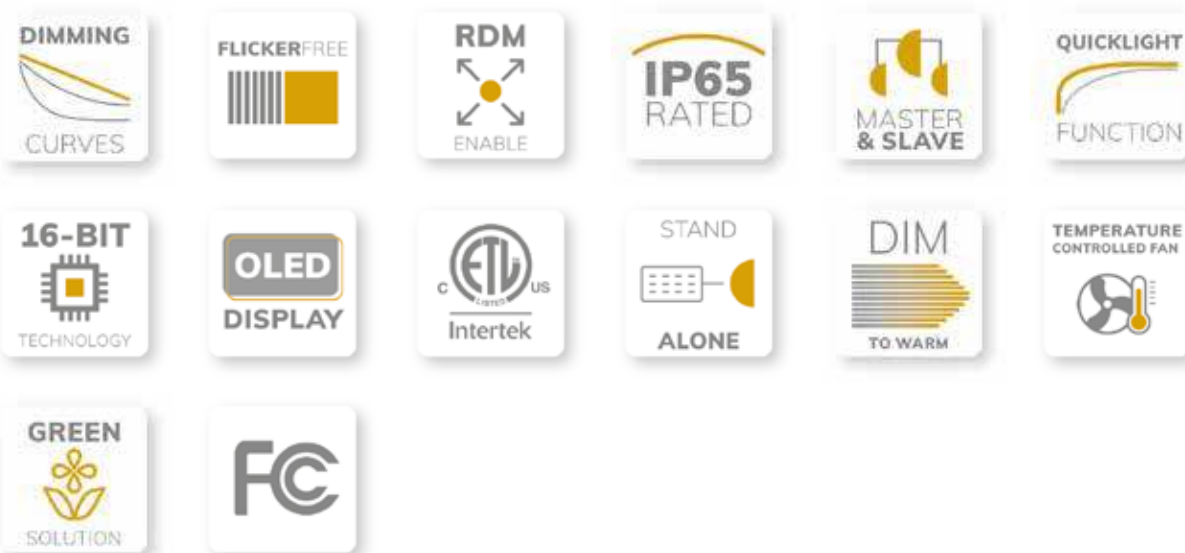



## 4. INSTALLATION & SETUP

### 4.1 Physical Installation and Rigging

ROXX CLUSTER B4 W may be installed in any orientation. For this purpose the product provides several options:

#### Standing:

The fixtures Yoke includes two M8 inner threads to install the optional ROXX YOKE FLOOR EXTENSION.

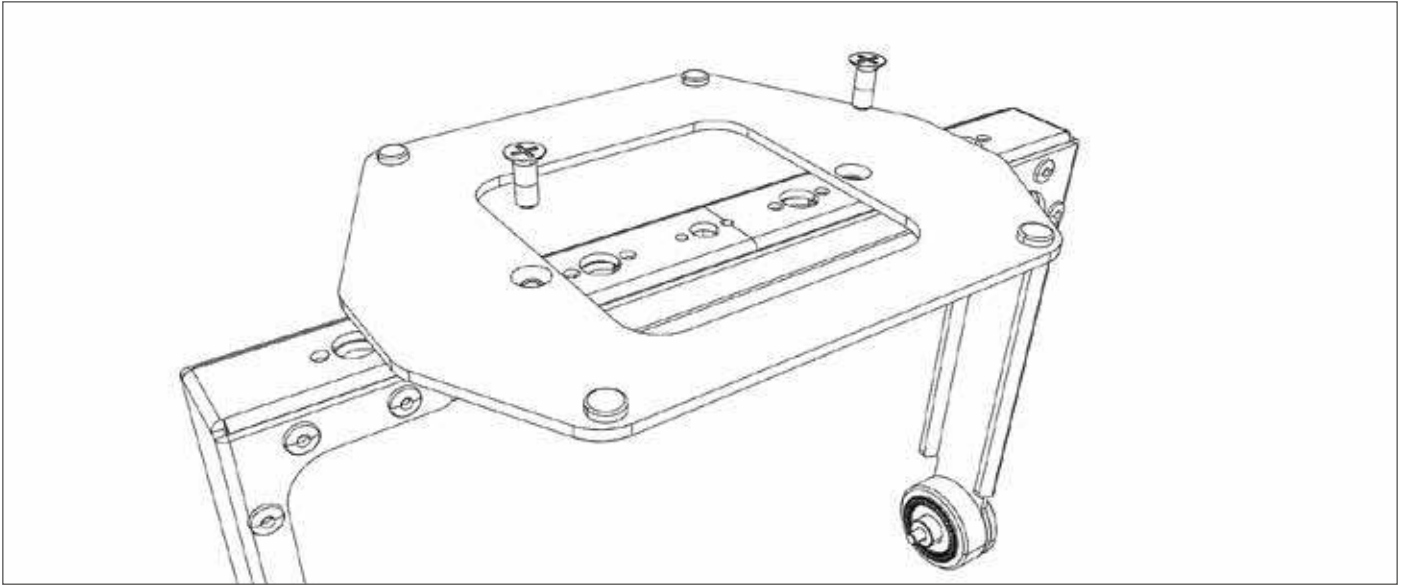

#### Hanging:

The fixture can be installed in different ways:

1. Directly by integrated 1/4 turn Camlocks on top- or rear side

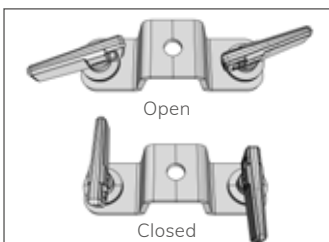
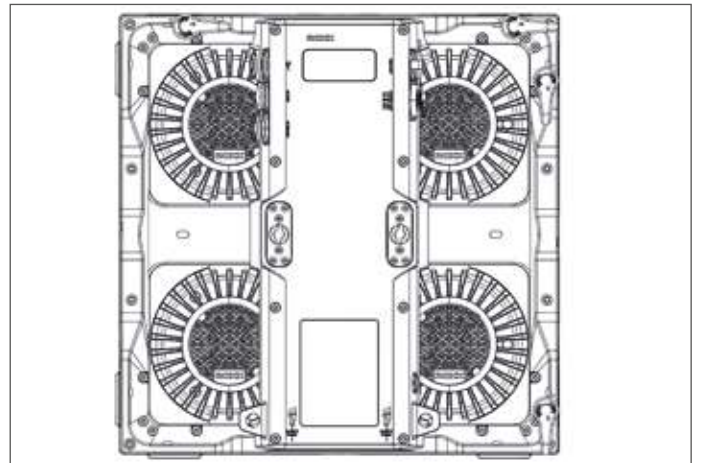
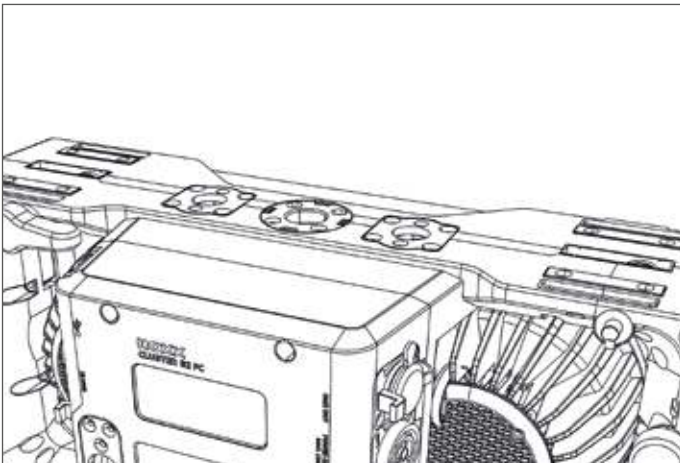

2. By included yoke with several mounting points:

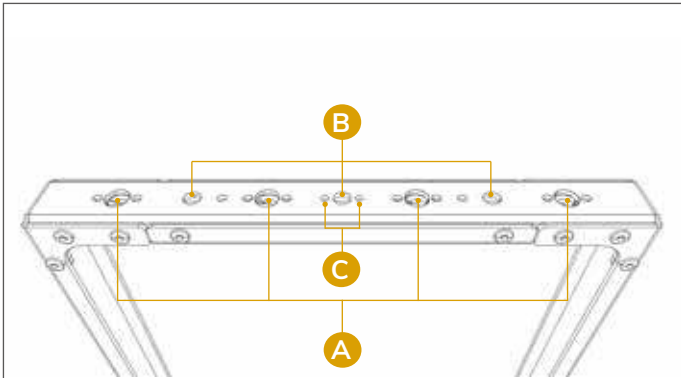

Multiple mounting points:

A: 3x Camlock with ¼ turn adapters

B: 3x M12 / ½"

C: 1x TV Spigot

Additional Yoke anchor points:

In the delivery state, the yoke is preinstalled in such a way that the individual eyes can be rotated  $\pm 20^\circ$  in the pan. Each CLUSTER device also provides side anchor points for the yoke so that the device can then be rotated either clockwise or counterclockwise so that the individual eyes can then be adjusted  $\pm 20^\circ$  in tilt movement.

In addition, the B4 W and B4 FC models offer a third, lower anchor point that can be used to mount the optional YOKE 4.3 to optimize the center of gravity on, for example, a 6-lite or 8-lite.



**Attention!**

**This should only be used when clustering several units together, as otherwise the center of gravity of the individual unit is no longer in the middle and the unit can unintentionally tip over when the yoke is released.**

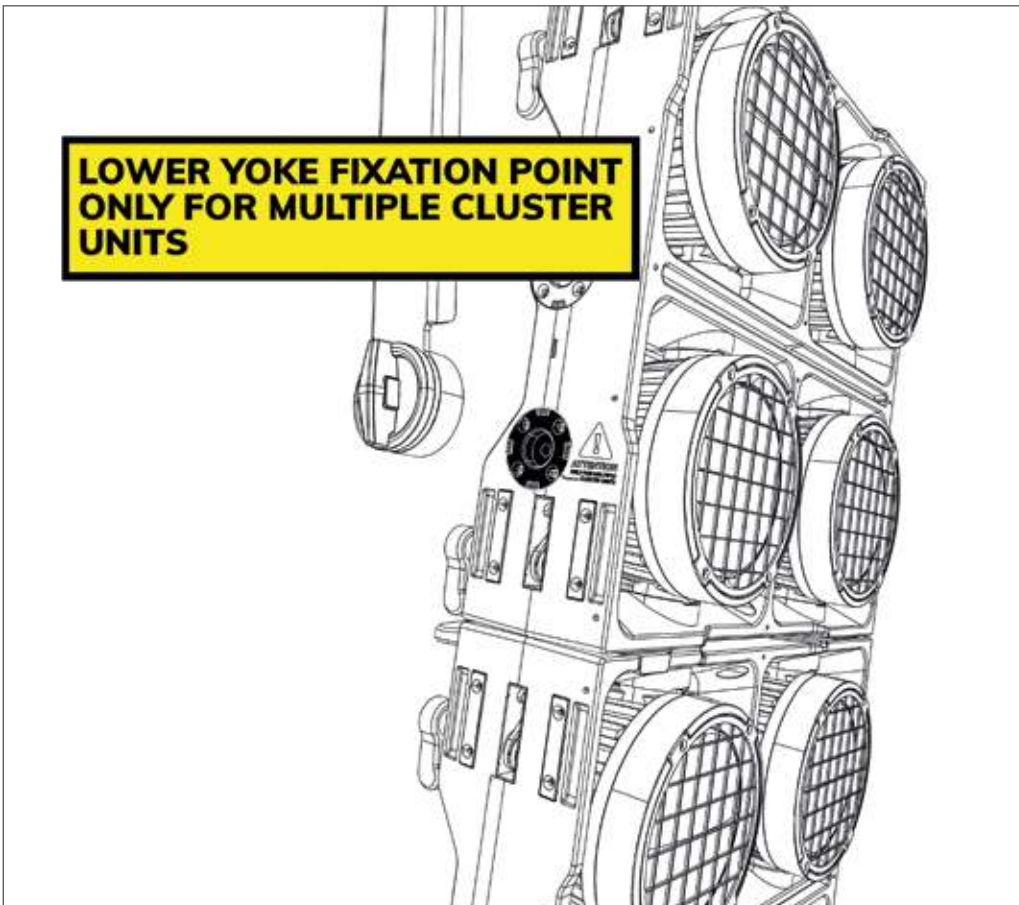

### 3. Using optional ROXX RIGGING BRACKET

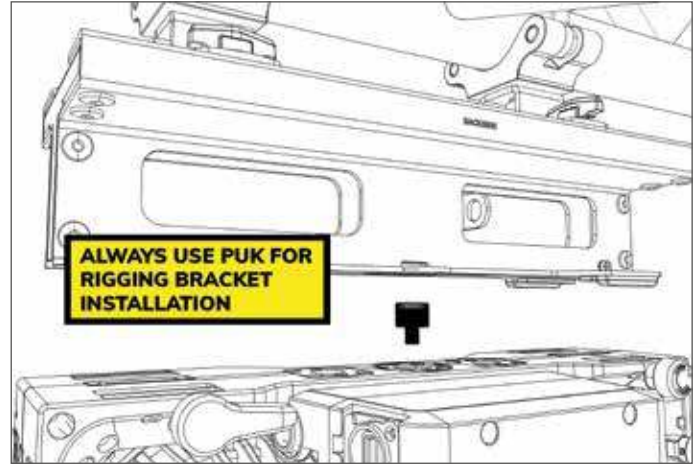
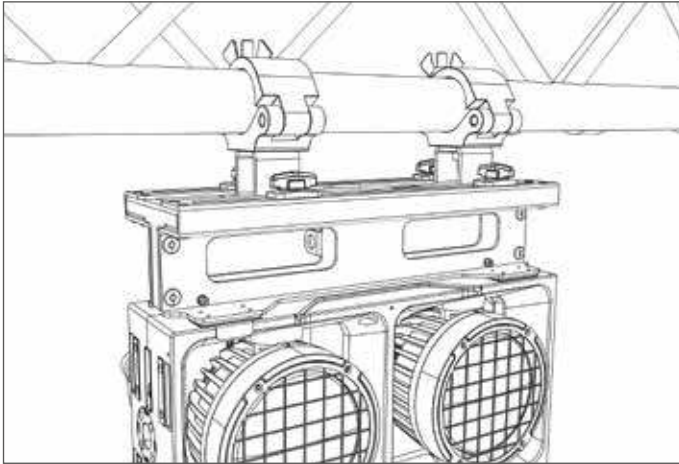

For seamless connection of multiple Blinders, to avoid gaps due to bracing of the truss structure by variable, sliding mounting positions.



#### Product Clustering

All CLUSTER products can be easily connected both horizontal and vertically, by using the integrated C-Lok system. The series is made to enable toolless multiple array configurations, scalable from a single vertical line, to massive matrix like arrays.

To connect the devices with each other, proceed as follows in sequence:

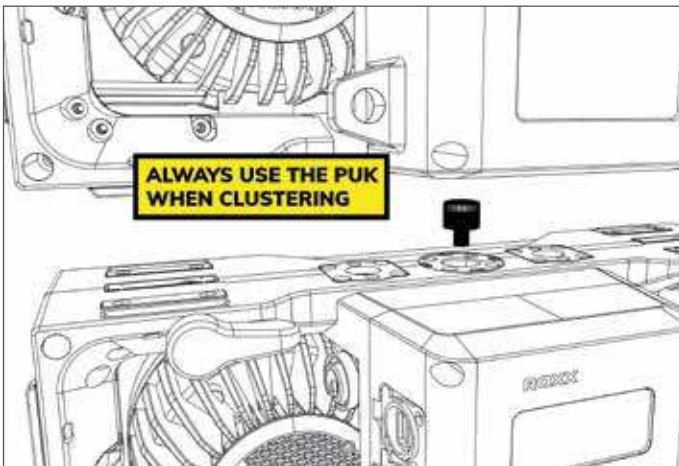

1. Bring the devices together with the respective top and bottom side.

A so-called centering puk is pre-installed on the top of every cluster device.

This should always be installed when connecting the devices to each other.

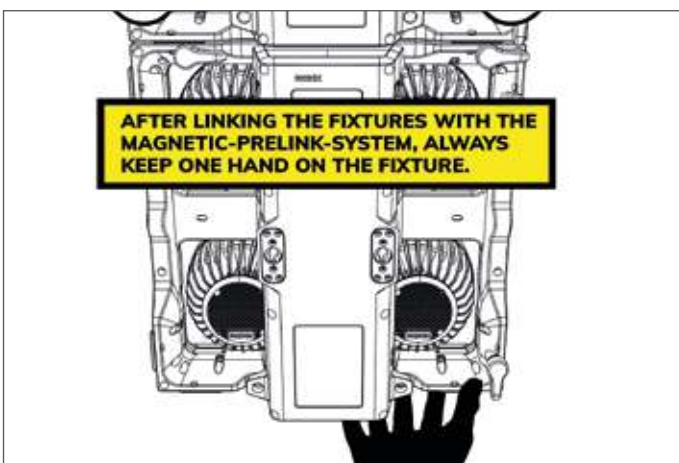

2. Pre-Link Magnets on top and side help to align the fixtures due cluster process and giving support operation for convenient and save interlocking.



#### Important Note:

Even though the pre-link magnet system is strong enough to hold the devices together, at least one hand must always remain on the device for support during the connection.



3. Make sure that the C-Lok hooks are turned counterclockwise (CCW) to the end-position first before you finally lock the C-Loks.

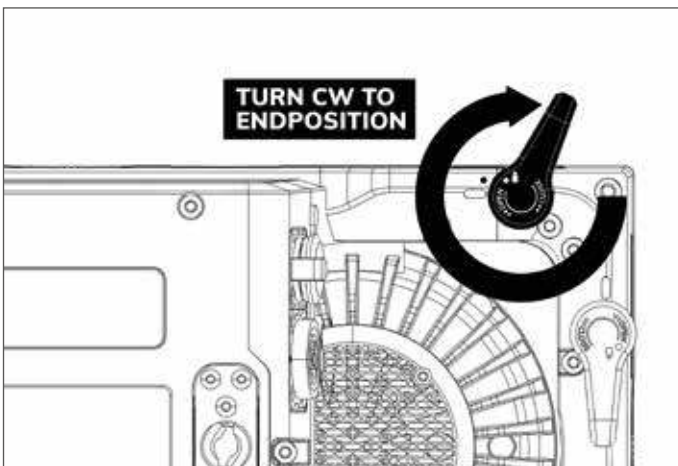

4. For locking all C-Lok's, please turn them clockwise into end-position.

**Note:**  
As soon as both dot indicators are in line, the C-Lok is securely locked



#### Maximum Tensile and Torsion Load

Before setting up Cluster configurations, be aware of the maximum tensile and torsion load, listed here below. Also make sure the mounting clamps are capable of supporting the total weight of your configuration.

The different rigging options of all Cluster products result in different maximum tensile and torsion loads that must not be exceeded for a safe overhead installation.

#### The maximum loads listed here below take into account the 10-fold safety!

1. Rigging by integrated 1/4 turn Camlocks on top- or rear side

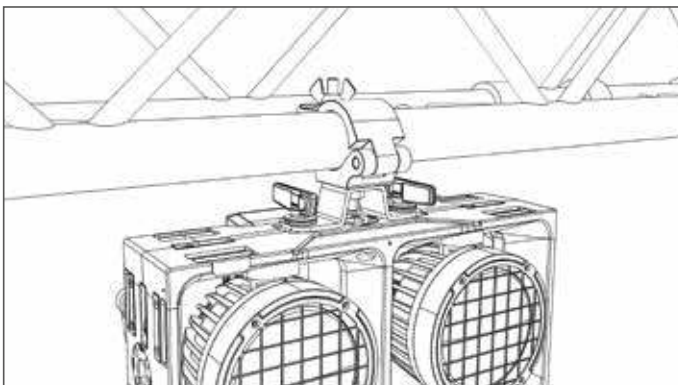

Max. Tension Load: 90kg  
Max. Torsion Load: 14.500 Nmm

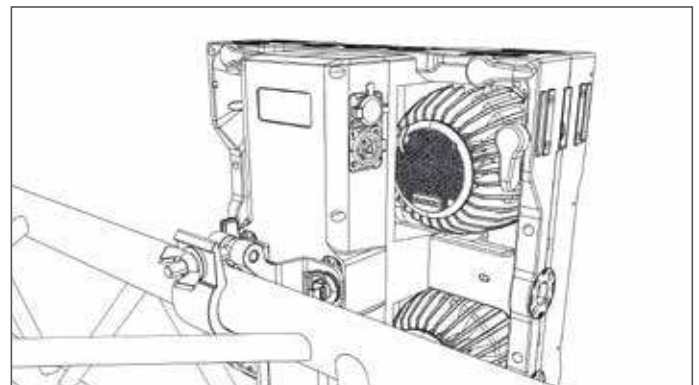

Max. Tension Load: 90kg  
Max. Torsion Load: 6.700 Nmm

## 2. Rigging by Yoke with multiple mounting points

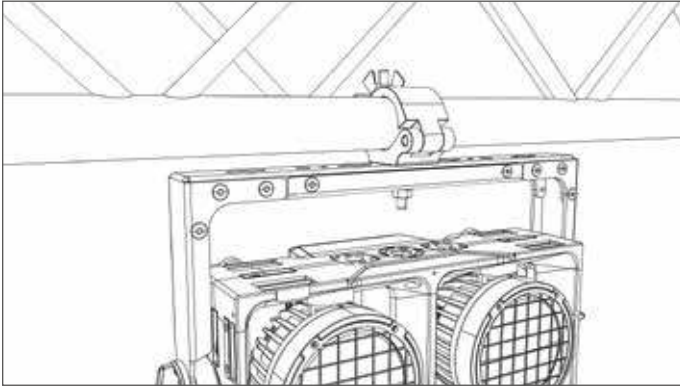

### a. With 1x Mounting Clamp

Max. Tension Load: 41kg

Max. Torsion Load: 4.280 Nmm

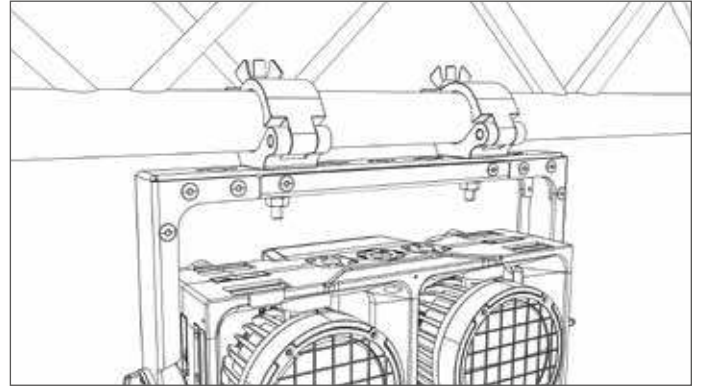

### b. With 2x Mounting Clamp

Max. Tension Load: 90kg

Max. Torsion Load: 9.096 Nmm

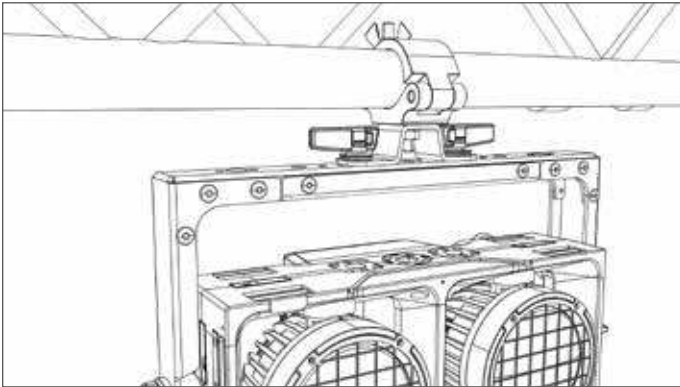

### c. With 1x Omega Bracket

Max. Tension Load: 49kg

Max. Torsion Load: 5.041 Nmm

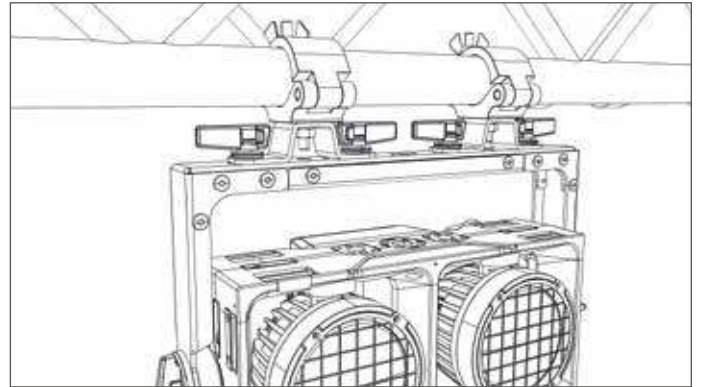

### b. With 2x Omega Bracket

Max. Tension Load: 90kg

Max. Torsion Load: 10.808 Nmm

## 3. Using optional ROXX RIGGING BRACKET with 2x Mounting Clamps

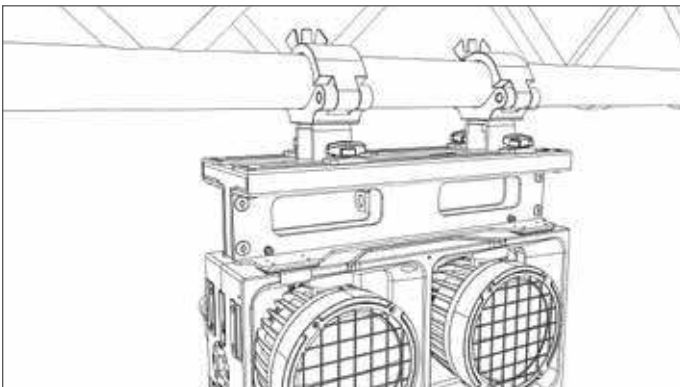

Max. Tension Load: 72kg

Max. Torsion Load: 6.326 Nmm



**Important Note:**  
Please be aware of using the centering PUK for safe RIGGING BRACKET installation to the CLUSTER device.

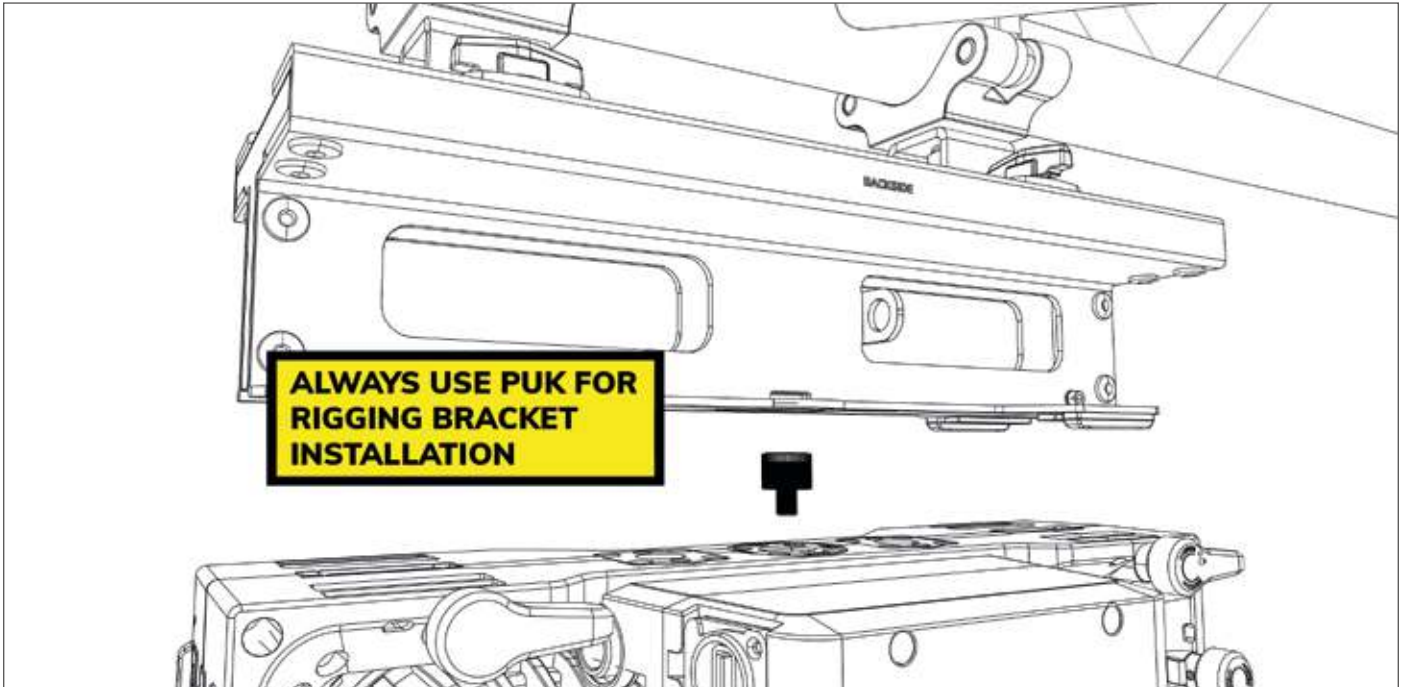

## 4.2 Connections\*

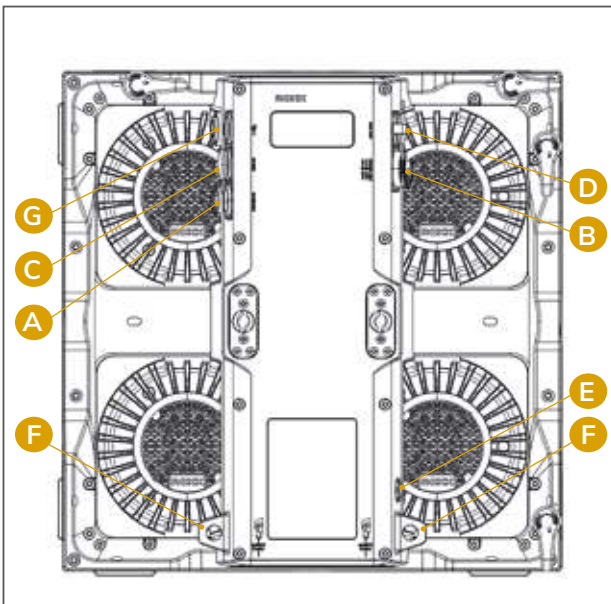

**A: Mains In:** IP65 Power input connector with rubber sealing cap. Connect using the provided power cable (when not in use, always close with rubber sealing cap).

**B: Mains Out:** IP65 Power output connector with rubber sealing cap. Provides power to additional fixtures. Ensure that the total power consumption of all daisy-chained devices connected do not exceed 8A (Ampere)! (when not in use, always close with rubber sealing cap).

**C: DMX IN:** Male IP65 5-pin XLR connector (when not in use, always close with rubber sealing cap).

**D: DMX OUT:** Female IP65 5-pin XLR connector when not in use, always close with rubber sealing cap).

**E:** GoreTex

**F:** Safety Eyelet

**G:** IP65 USB port for firmware updates

### ① \*Note:

In order to provide protection from spraying water, in accordance with protection class IP65, special IP65-rated XLR connectors must be used correctly with the DMX input and output sockets, or they must be closed using the rubber sealing caps. When connected correctly, or when sealed correctly with the rubber sealing caps, the POWER IN and POWER OUT sockets are protected from spraying water, as in accordance with IP65.

#### 4.2.1. AC Power

The CLUSTER B4 W operates on any 100–260 V, 50/60 Hz AC mains power supply with a maximum power consumption of 220W.

Connect the fixture to AC power using the supplied cable or a similar one with Neutrik powerCON TRUE1 NAC3FX-W or a compatible type, to ensure the correct ingress protection (IP).

For temporary installations, the mains cable must be fitted with a grounded connector intended for exterior use. The fixture must be grounded/earthed and be able to be isolated from AC power. The AC power supply must incorporate

Wire Color (EU models)	Wire Color (US models)	Conductor	Symbol
Brown	Black	Live	L
Blue	White	Neutral	N
Yellow / Green	Green	Ground (earth)	⊕ or ⊚



a fuse or circuit breaker for fault protection.

#### Warning!

Read “Safety Informations” starting on page 3 before connecting the fixtures to AC mains power! Do not connect the fixture to an electrical dimmer system, as doing so may cause damage that is not covered by the product warranty!

#### 4.2.2. DMX Connection

The CLUSTER B4 W is fully controllable by DMX (USITT DMX512-A standard, based on RS-485) and RDM.

##### 4.2.2.1. Cable Connection

If using a cabled DMX system, connect the DMX IN cable to the input connector (male 5-pin XLR connector) and DMX OUT cable to the output (female 5-pin XLR connectors).

For outdoor installations, use only IP65-rated XLR connectors.

Use shielded twisted pair cable designed for RS-485 devices. The cables are daisy chained between the fixtures, and up to 32 fixtures can be connected to the same DMX link. Up to 300 meters (1000ft.) of cable is achievable with high quality DMX cables. All DMX links must be terminated in the last fixture by connecting a DMX termination plug to the last fixture’s 5 pin DMX out connector.

Standard microphone cable is not suitable for transmitting DMX.

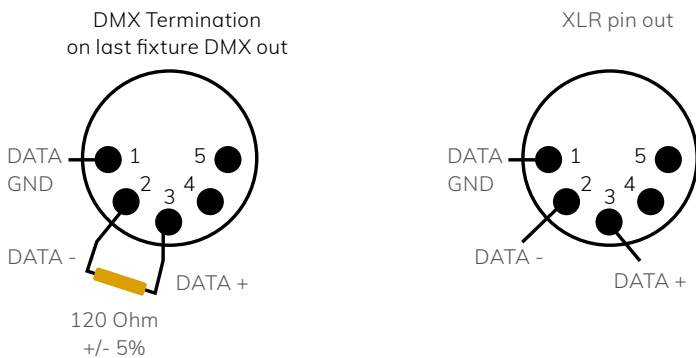

## 5. OPERATION

### 5.1 Start up\*

Once the fixture is connected to AC power, the boot process starts and the following information will appear on the display:

“Ready to ROXX”, the product name and the current software version.



After this process, the fixture is ready for operation, and starts in the previously enabled mode.

**\*Note:**

**During boot process the fan spins up quickly to blow out some possible dust from last use.**

### 5.2 Control Display\*

OLED Display with Touch-Sensitive controls



Press **ENTER** to access the selection menu for system settings or confirm changes.



Press **ESC** to take a step back in the menu.



Press **arrows to scroll up and down** inside the menu and change values, such as DMX address.

**\*Note:**

**For a smooth navigation thru the menu settings, please make sure the display surface is dry and dust free.**

**After approximately 1 minute of inactivity inside the menu settings, the display will automatically jump back to home screen.**

### 5.3 Display Short Cuts\*

Short Cuts

For some always recurring functions the fixture allows quick and user-friendly access at home screen over some display control short-cuts:

#### User Reset or Factory Reset\*



Pressing **ESC+ENTER** simultaneously a Factory Reset or User Reset can be started.

By using the up/down arrows the Factory- or User Reset can be selected.

For confirming press **ENTER**, to jump back please press **ESC**.

**\*Note:**

**After Factory Reset all fixture settings are set back to factory default values.**

**After User Reset all user selected reset functions and user default values will set back.**

**Also a short self-test will start immediately while dimming in and out each single color.**



## Display Off



Pressing ESC + arrow down simultaneously the display backlight function will set to off and the display will turn off immediately. Once a control is pressed the display backlight will turn on.

## Manual display flip function\*



The fixture includes an auto display flip function by default.

To use the manual display flip function please disable the auto flip function under Settings / Display first. Once the auto display flip function is disabled you can use the manual display flip function by pressing arrow up + arrow down simultaneously. The display will rotate 180. By pressing both arrows simultaneously again the display will flip back.

### \*Note:

**Once the display is flipped both Up / Down controls will work according to the display rotation.**

## Quick Light function

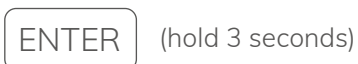

For easy and fast operation during setting the lights the fixture includes a user-friendly Quick Light function. If DMX is not assigned please press and hold ENTER for 3 seconds at homescreen, after the Quick Light function will appear. Here dimmer can be adjusted from 0-100% by using up/down arrows, to take over the dimming value please press ENTER to confirm.

## 5.4 Configuration

### Home Screen

After boot process the fixture is ready for operation and starts in the previously enabled mode. At home screen the following information will appear, depending on the current operating mode:

- A DMX Address
- B Operating Mode (DMX Mode, Quick Light or Standalone Mode)
- C Next available DMX address depending on the fixtures DMX footprint
- D External Data protocol (DMX).
- E The dot indicates the active protocol

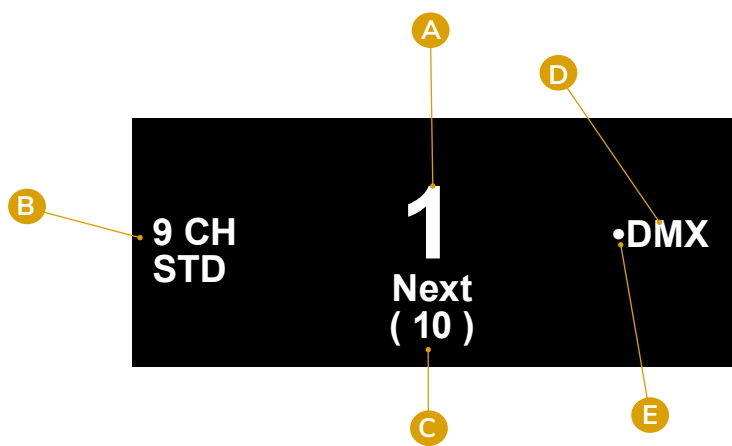

#### 5.4.1 Set DMX Start Address (Direct Access)

At Home Screen the DMX address can be changed directly by using the up and down arrows. During this process the DMX address starts blinking, once it's confirmed by pressing ENTER it stops blinking.

If the DMX address will not be confirmed by ENTER within 10 seconds, the display will jump back and show the DMX address from before and stops blinking.

#### 5.4.2 Selecting DMX Mode\*

At home screen please press ENTER to access to the main menu (level 1).

While using UP / DOWN arrows, please select the menu item "DMX Mode" and confirm by pressing ENTER.

In the following sub-menu (level 2), you can now choose between 8 different DMX operating modes while using the UP/Down arrows and confirm by pressing ENTER or jump back by pressing ESC.

After confirmation the display will jump back to main menu (level 1). Press ESC for homescreen, here the selected DMX mode will be displayed.

#### ① \*Note:

**For detailed information about the several DMX modes including channel assignment please see our DMX Control chart.**

Level 1

Menu
<ul style="list-style-type: none"> <li>➤ DMX Mode</li> <li>Stand Alone</li> <li>Slave</li> <li>Settings</li> <li>System Info</li> </ul>

Level 2

DMX Mode
<ul style="list-style-type: none"> <li>➤ 1CH DWE</li> <li>2CH DWE</li> <li>4-1CH DWE</li> <li>4-2CH DWE</li> <li>7CH STROBE</li> <li><b>9CH STANDARD</b></li> <li>12CH EXTENDED</li> <li>17CH EXTENDED</li> </ul>

### 5.4.3 Stand Alone\*

Press ENTER to access to main menu (level 1).

While using the UP / DOWN arrows, please select the menu item “Stand Alone” and confirm by pressing ENTER.

In the following sub-menu (level 2), you can now choose between 2 different Stand Alone operating modes (Auto, Quick Light), Stop Stand Alone while using the UP/Down arrows and confirm by pressing ENTER or jump back by pressing ESC.

To finally use Stand Alone programs please make sure DMX is disconnected to the fixture, as this protocol has priority.

#### Stop Stand Alone

To stop a running Stand Alone mode immediately, please select “Stop Stand Alone” and confirm by pressing ENTER. The display will automatically jump back to level 1.

Level 1

Menu
<ul style="list-style-type: none"> <li>DMX Mode</li> <li>➤ Stand Alone</li> <li>Slave</li> <li>Settings</li> <li>System Info</li> </ul>

Level 2

Stand Alone Mode
<ul style="list-style-type: none"> <li>➤ Stop Stand Alone</li> <li>Auto</li> <li>Quick Light</li> </ul>

#### Auto\*

Select “Auto” by using the up/down arrows and press ENTER.

Here at sub-menu (level 3), you can choose between 5 different Auto Effects (Effect 1 - 5) and Stop Program. Using the Up/Down arrows you can select one of the 5 Effects and confirm by pressing ENTER or step back by ESC.

After confirming your preferred Effect, you can now adjust speed and brightness at level 4.

To adjust speed, please use the UP / DOWN arrows to select the menu item “Speed”, and confirm with ENTER. After use UP / DOWN arrows to adjust the speed value between 000-100 and confirm by ENTER or jump back by ESC.

To adjust brightness please select “Dim” as per the procedure previously described and confirm with ENTER. After use UP / DOWN arrows again to adjust the brightness value between 000-100 and confirm by ENTER or jump back by ESC.

Once it's confirmed or denied the display will automatically jump back to level 3.  
 To stop running a selected Effect please chose "Stop Program" at level 3 or "Stop Stand Alone" at level 2.  
 For returning back to homescreen please press ESC three times.  
 At homescreen the selected Stand Alone mode "Auto" and the selected program will be displayed.

**\*Note:**

Using arrows UP /DOWN at homescreen Auto programs can be directly changed according to the list.

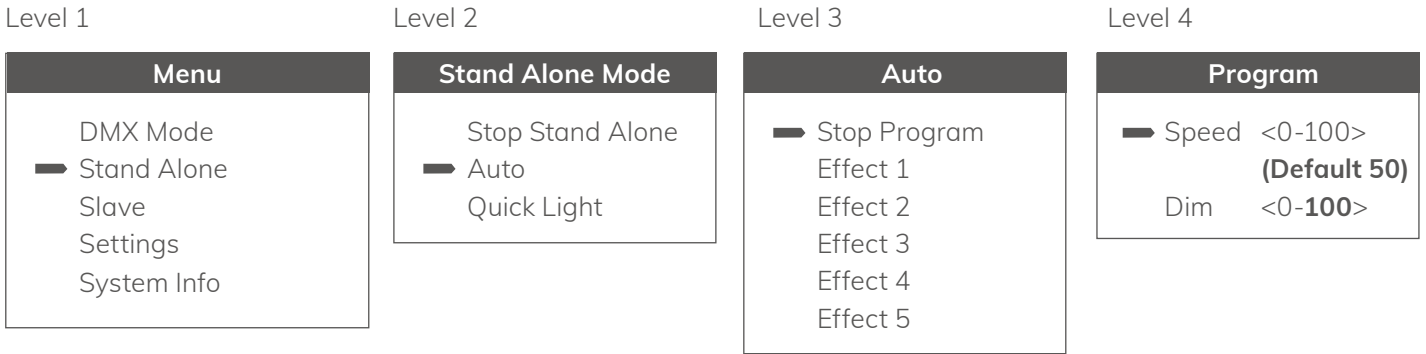

**Quick Light\***

The standalone mode "Quick Light" allows a direct adjustment of the single eyes brightness and dimmer and shutter.

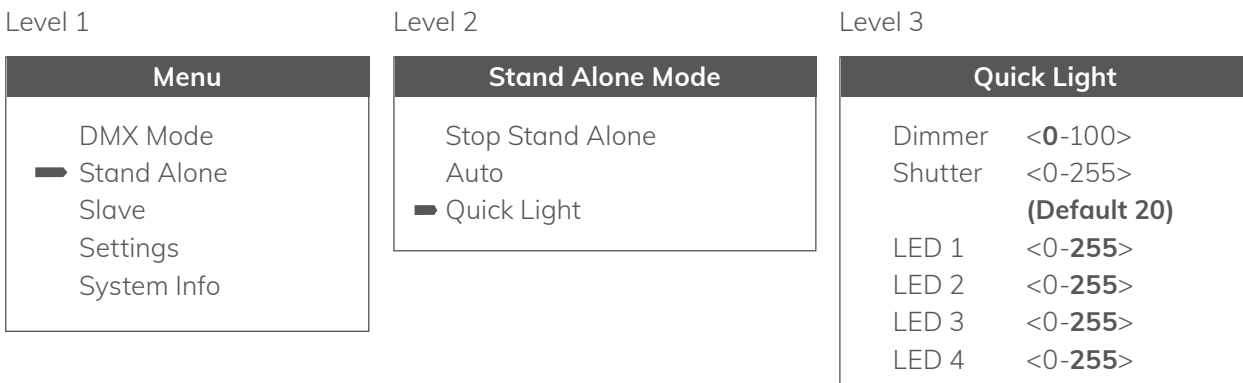

To adjust your Quick Light please press ENTER to access to main menu (level 1).  
 While using the UP / DOWN arrows select the menu item "Stand Alone" and confirm by pressing ENTER. After please select the item "QuickLight" by using the up/down arrows and press ENTER again.  
 Using UP and DOWN controls, select your desired color and confirm with ENTER.  
 After you can adjust the brightness for each eye between 000-255 and confirm by ENTER.  
 Besides the individual color mix also a master dimmer can be adjusted between 000-100.  
 For strobe effects please adjust the Shutter value between 000-255.

**\*Note:** Please see detailed explanation for strobe effects inside DMX chart at the end of this manual.  
 Using UP/DOWN arrows at homescreen you can change Quick Light dimmer value.

#### 5.4.4 Slave Mode\*

Slave Mode allows same model fixtures to be controlled by the “Master” fixture via DMX). The “Master” device should run in Stand Alone mode, all “Slave” devices should set to “Slave”.

Level 1

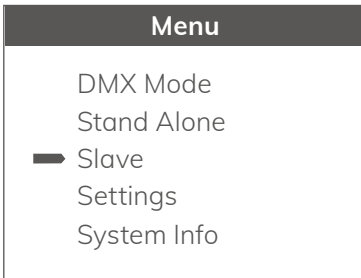

To select “Slave” please press ENTER to access to main menu (level 1).

While using the UP / DOWN arrows, please select the menu item “Slave” and confirm by pressing ENTER. Now this unit is set to “Slave”. Please connect the slave and the master devices (same model) with a DMX cable and enable one of your preferred standalone mode on the master device. Once the Stand Alone mode is activated all slave devices will follow the master device.

**ⓘ Note: All devices should use same software version.**

**Once Stand Alone mode is disabled at Master unit the display of Slave unit starts to blink.**

#### 5.4.5 Settings

Level 1

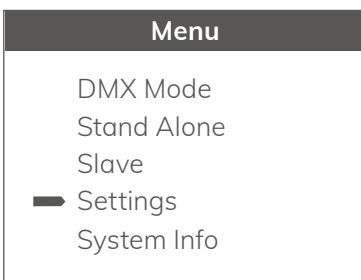

Main Menu	Menu level 2	Menu level 3	Menu level 4	Description	
Settings Settings	Display	Display Flip	<on/off>	On= Flip control panel display by 180° (e.g. for overhead installation) Off= normal control panel display	
		Backlight	<on/off>	On= controls permanent on, display itself will deactivate after 60 minutes of inactivity Off= controls and display deactivation after approximately 1 minute of inactivity	
		Auto Lock	<on/off>	On= Automatically locks the controls after approximately 1 minute of inactivity. After attempted input the display shows: „Locked!“ Unlock process: press arrows up, down, up, down consecutively	
	Startup Mode (using last adjustments of specific Standalone Modes)	<b>DMX</b>			Select your default operating mode when fixture is powered on
		Auto			
		Quick Light			
	DMX Fail	<b>Hold</b>			Hold= last command retains
		Blackout			Blackout= Activates Blackout
		Emergency Light			Emergency Light= Fixtures changes to full on
	Dimmer Curve	Linear			Linear= Light intensity increases linear with DMX value
		<b>Exponential</b>			Exponential= Light intensity can be set more smooth at lower DMX values and broadly at higher DMX values.
		Logarithmic			Light intensity can be broadly adjusted at lower DMX values and more smooth at higher DMX values
		S-Curve			Light intensity can be adjusted smoothly at lower and higher DMX values and broadly at medium DMX values
	Dimmer Response	LED			The LED responds abruptly to its DMX values
		Medium			The LED responds with medium delay to DMX value changes at brightness
		<b>Halogen</b>			The LED responds similar to a halogen fixture with soft changes at brightness.
	Redshift	<b>On / Off</b>		On= Activates Redshift, Off= Deactivates Redshift	Redshift function simulate traditional halogen fixtures while dimming down. Redshift affects only between 2700-3500K.
	RAW Balance (affects RAW Mode in DMX and Stand Alone Modes)	<b>RAW</b>			W,A,R with maximum value of brightness
		User Calibration		White 1 <0-255>	individual color calibration of W,A,R for each single eye
				Amber 1 <0-255>	
				Red 1 <0-255>	
White 2 <0-255>					
Amber 2 <0-255>					
Red 2 <0-255>					
White 3 <0-255>					
Amber 3 <0-255>					
Red 3 <0-255>					
White 4 <0-255>					
Amber 4 <0-255>					
Red 4 <0-255>					

	LED Frequency	800 Hz		Select preferred LED PWM frequency
		<b>1200 Hz</b>		
		2000 Hz		
		3600 Hz		
		12000 Hz		
		25000 Hz		
	Fan	<b>Auto</b>		Adjust fan speed relative to internal fixture temperature
		Silent		Low fan speed for silent operation
		Fan Off		Fan Off
		Max. Power		High fan speed for maximum cooling effect
	Invert Mapping	<b>Off</b>		No Pixel Invert
		CW		Inverts the Pixel Layout clockwise, Pixel #3 becomes Pixel #1
		CCW		Inverts the Pixel Layout counter-clockwise, Pixel #2 becomes Pixel #1
	Transfer Configuration	Including DMX Address		Transfer the same menu settings of this fixture to all the other in daisy chain (same model), either with DMX address or without. After power off and on again, the transferred settings should stay the same.
		<b>Without DMX Address</b>		
	LED Mode	Illumination		Normal output for constant illumination
		<b>Boost</b>		Boost for temporarily highest output for blinder and strobe effects
	USB Update	Yes		Run firmware update via USB port
		<b>No</b>		Do not run firmware update via USB port
	Factory / User Reset	Factory Reset	Are you sure to reset? Confirm by pressing ENTER, cancel with ESC	Restores all factory defaults including User Colors, but no User defaults.
		User Reset	Are you sure to reset? Confirm by pressing ENTER, cancel with ESC	Restores all User Reset according to the User Preset List. Timer Function and DMX address restore to Factory default. Once User Reset is activated a fixture self test will start.

Main Menu	Menu level 2	Menu level 3	Menu level 4	Menu Level 5	Description
Settings	Factory / User Reset	User Reset List	1CH DWE, 2CH DWE, 4-1CH DWE, 4-2CH DWE, 7CH STROBE, <b>9CH STANDARD</b> , 12CH EXTENDED, 17CH EXTENDED		Select your User Reset defaults
			Display Flip	<on/off>	
			Backlight	<on/off>	
			Auto Lock	<on/off>	
			Startup Mode	< <b>DMX</b> /Auto, Quick Light>	
			DMX Fail	< <b>Hold</b> /Blackout/Emergency (Light)>	
			Dimmer Curve	<Linear, <b>Exponential</b> , Logarithmic, S-Curve>	
			Dimmer Response	<LED, Medium, <b>Halogen</b> >	
			Redshift	<on/off>	
			LED Frequency	<800Hz, <b>1200Hz</b> , 2000Hz, 3600Hz, 12000Hz, 25000Hz>	
			RAW Balance	<b>RAW</b> / User Calibration	
			Fan	< <b>Auto</b> , Silent, Studio, Fan Off, Max. Power>	
			Invert Mapping	< <b>off</b> , CW, CCW>	
			Transfer Configuration	<including DMX address / <b>without DMXaddress</b> >	
			LED Mode	<Illumination, <b>Boost</b> >	
USB Update	<yes/ <b>no</b> >				



## Pixel Arrangement

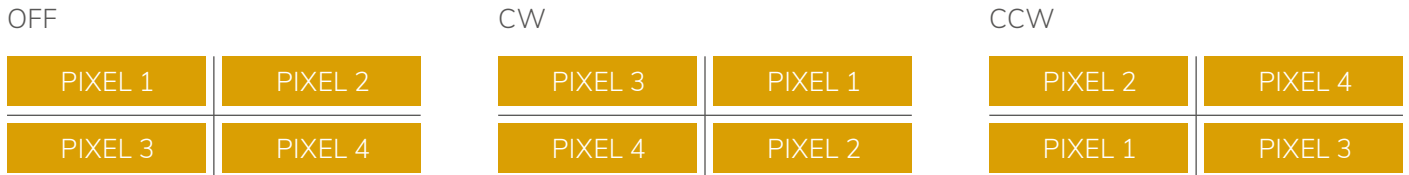

## Dimmer Curves

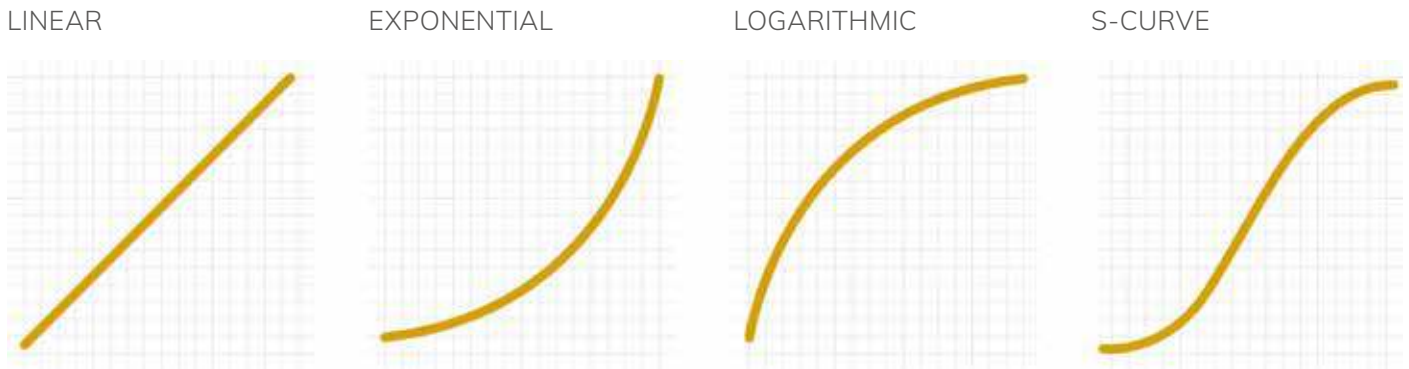

## 5.4.6 System Info

Level 1

Menu
DMX Mode
Stand Alone
Slave
Settings
— System Info

Main Menu	Menu level 2	Menu level 3	Menu level 4
System Info	Firmware Version	vx.xx	Display installed firmware version
	Serial Number	201xxxxxxxx	
	RDM UID	0X6a6axxxxxxxxx	Display unique RDM ID for identification
	Temperatures	LED 1: Celsius/Fahrenheit : XXX°C / XXX °F LED 2: Celsius/Fahrenheit : XXX°C / XXX °F LED 3: Celsius/Fahrenheit : XXX°C / XXX °F LED 4: Celsius/Fahrenheit : XXX°C / XXX °F	Display LED 1-4 temperature by celsius and fahrenheit
	Power on Time	Total: LED 1: xxxxxhours LED 2: xxxxxhours LED 3: xxxxxhours LED 4: xxxxxhours	Display fixture total power on time
	LED on Time	Total: xxxxxhours	Display LED 1-4 total power on time
	Errors	Errors information	Display error codes

## 6. ACCESSORIES



Yoke 4.3  
Art.: 13907101



Floor Extension  
Art.: 13907201



Rigging Bracket  
Art.: 13907411



Omega Bracket ST  
Art.: 90900002



Case 4 pcs. / 8 pcs. Art.: 13907411  
Case 2 pcs / 4 pcs Art.: 13907511

## 7. TECHNICAL DATA / DIAGRAMS

### 7.1 Technical drawings and measurements

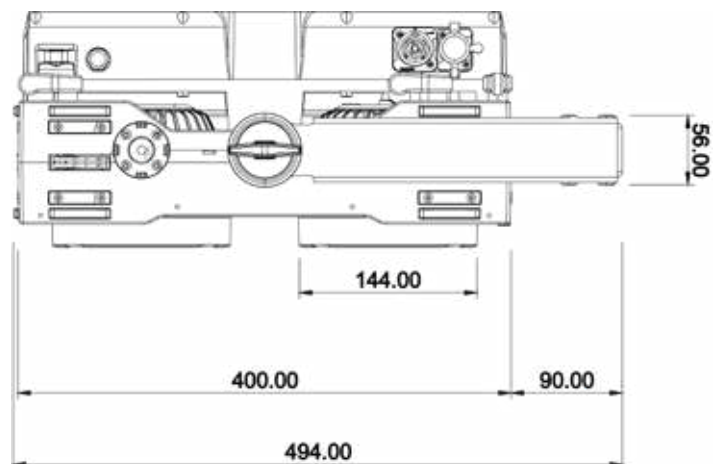
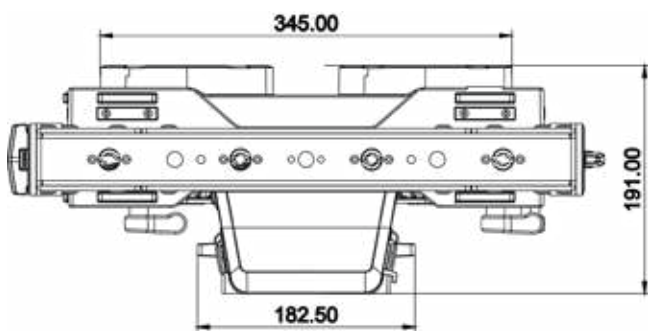
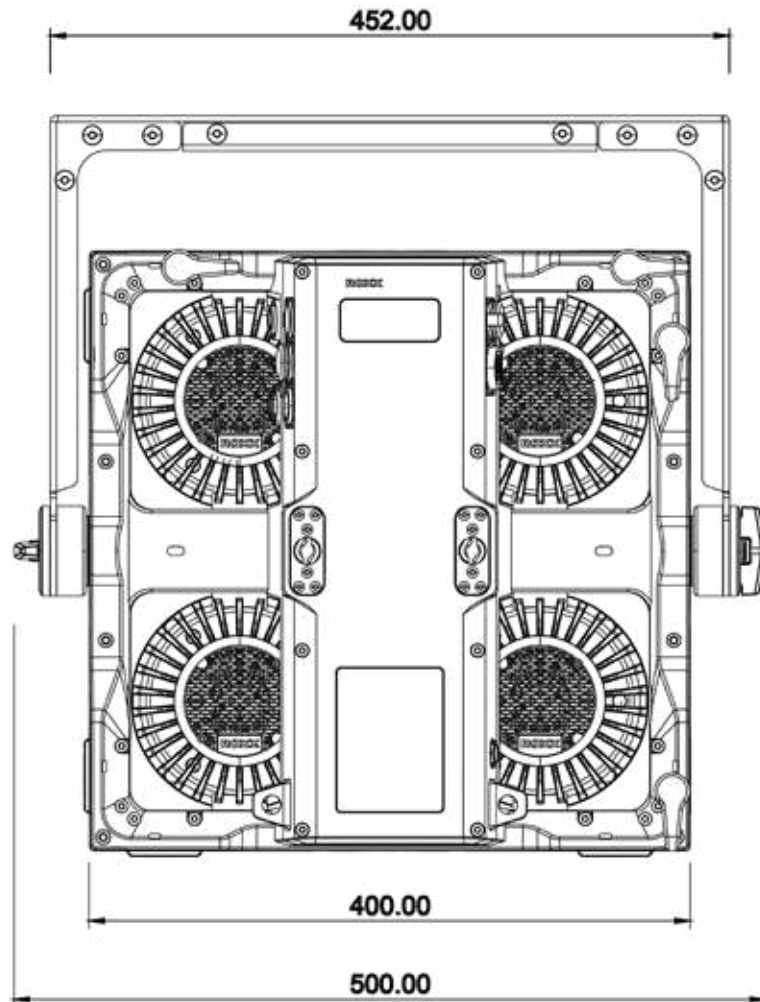

## 7.2 IP Rating

ROXX products conform to officially classified IP standard levels. CLUSTER B4 W is rated to IP65 when using the covers for the housing parts. IP stands for Ingress Protection and IP65, according to classified standard, means shielded against dust and high-pressure jets of water from any side.

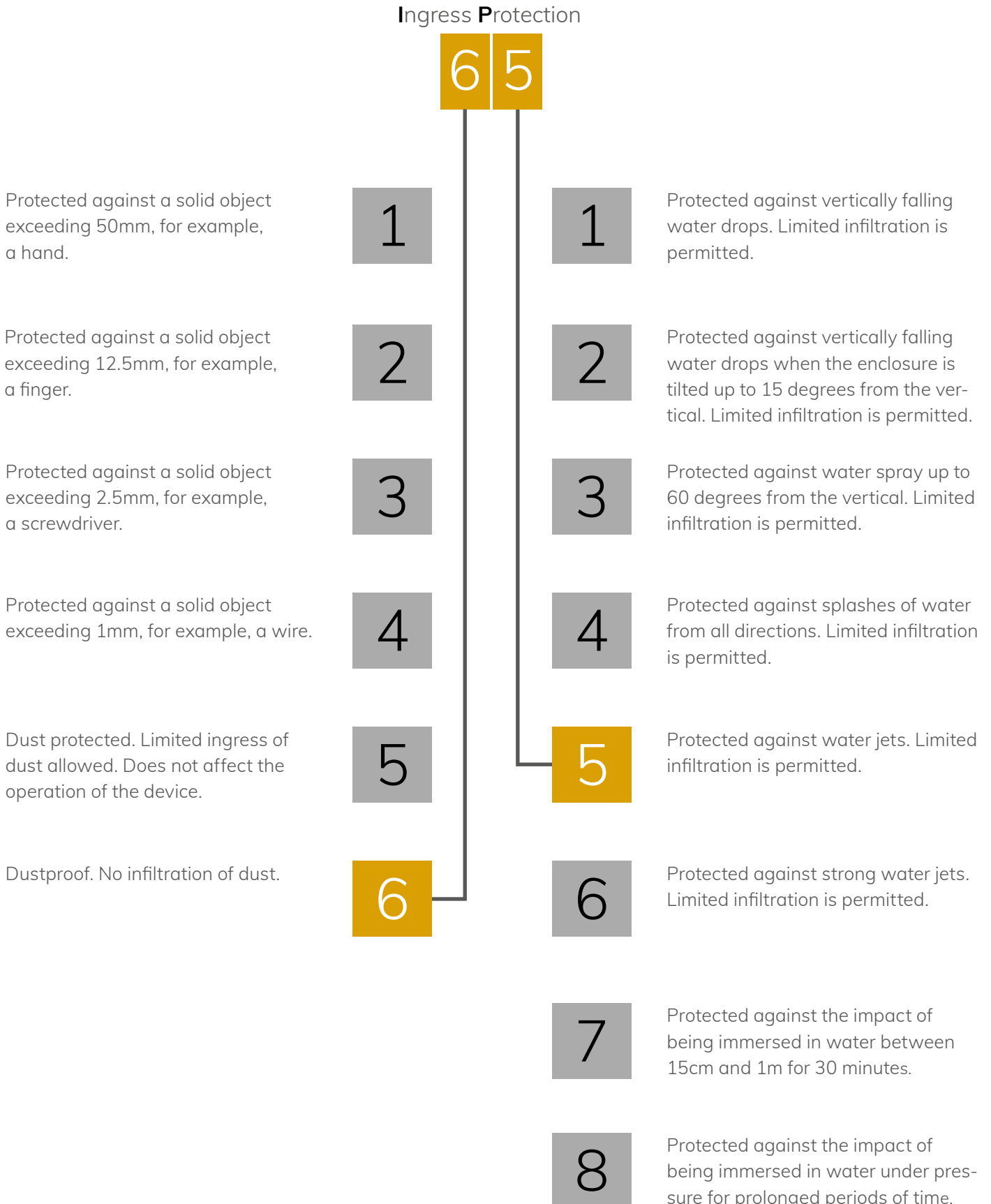

### 7.3 Technical Data

Photometrics	
LED expected lifetime	50.000 hours
Lightsource	4x 300W Warm-White + Amber + Red
Type of optical system	Reflector with Compound Eye Lens
LED PWM Frequency	selectable 800Hz, 1.200Hz, 2.000Hz, 3.600Hz, 12kHz, 25kHz
Beam angles (50%)	50°
Maximum Field angles (10%)	87°
Color temperature range	2.900K
Efficacy (max)	25,19 lm/W
CRI/RA	80
Luminous flux	34.000 lm
illuminance Lux @ 1m / 3,3ft	37870lx / 3518fcd
illuminance Lux @ 3m / 9,8ft	4295lx / 399fcd
illuminance Lux @ 5m / 16,4ft	1535lx / 143fcd
illuminance Lux @ 7m / 23,0ft	795lx / 74fcd
illuminance Lux @ 10m / 32,8ft	395lx / 37fcd
Thermal Characteristics	
Cooling	Active, Forced Air, Temperature-regulated
Humidity (max.)	95%
Temperature range, Operating	-40°C to 45°C
Temperature range, Start-up	-20°C to 45°C
Temperature range, Storage	-40°C to 80°C
Thermal Protection	Automatic overtemperature protection
Electrical Data	
AC Power, max	90 – 285V 50/60Hz
AC Power, nominal	100 – 240V 50/60Hz
Electrical protection	Overload protection with automatic recover
Max power consumption (Boost Mode)	1350W
Constant power consumption (Illumination Mode)	440W
Power Max. Out	9A @ 230V / 2A @ 120V
Power Linking @ Max Power Consumption (Boost Mode)	1 unit @ 230V / 0 unit @ 120V
Power Linking @ Constant Power Consumption (Illumination Mode)	7 units @ 230V / 2 units @ 120V
Power Factor	0.944 PF (230V) / 0.998 PF (120V)
Power Supply Unit	Inbuilt auto-ranging electronic switch-mode

### 7.3 Technical Data

Operator & Controller	
DMX Functions	Master Dimmer, Master Dimmer Fine, Shutter, Duration, Dimmer 1-4, Dimmer 1-4 Fine, Dimmer Curve, Dimmer Response, Redshift, Effect, Device Settings
DMX channels	1CH DWE, 4-1CH DWE, 4-2CH DWE, 7CH STROBE, 9CH STANDARD (default), 12CH EXTENDED, 17CH EXTENDED
DMX modes	18
Protocol	USITT DMX512A, RDM ANSI E1.20
Setting and addressing	OLED graphical display / 4 controls, RDM ANSI E1.20
Standalone mode	Auto Program, Quick Light
Wireless DMX	n.a.
Indicator	OLED graphical display
Controls	4 touch sensitive, backlighted controls
Strobe	0-20Hz
DMX I/O	IP65 XLR 5-pin male/female
Power In	TRUE1 compatible input & link-thru sockets
USB Firmware Update	IP65 USB socket
Dimensions & Weight	
IP class	IP65
IK class	IK08
Body material	Aluminum, Nylon
Lens material	Tempered glass front
Net dimensions (w x h x d)	400 x 400 x 191mm
Net dimensions inches	15,75 x 15,75 x 7,52 inches
Net weight (incl. Yoke)	16,2 kg (35,71lbs)
Tilt	360°
Tilt Locking System	Locking system with tothing and angle indicator
Included / Optional	
Included items	Yoke 4.2, 2m Power Cable, Puk
Optional Accessories	Yoke 4.3, Yoke Floor Extension, Rigging Bracket, Omega Bracket ST
Color options	Black – RAL 9004 (Standard) Custom color – any RAL (on request)
Installation	
Mounting point by Yoke (included)	3x 13mm / 1/2" holes, 1x centric TV Spigot attachment, 3x integrated Camlocks for Omega Brackets
Mounting point on fixture	1/4 turn Omega Bracket on top and rear side
Mounting point with optional Rigging Bracket	2x 13mm / 1/2" holes for Clamp fixation
Orientation	Any
Rigging possibilities	Hanging or ceiling / pendant mount
Safety features	2x rear mount for safety wire
Minimum distance from flammable materials	0,3 meters (11,8 inch)

## 7.4 DMX-Charts

**1CH DWE**

**2CH DWE**

**4-1CH DWE**

**4-2CH DWE**

**7CH STROBE**

**9CH STANDARD (default)**

**12CH EXTENDED**

**17CH EXTENDED**

CH	1CH DWE	2CH DWE	4-1CH DWE	4-2CH DWE
1	Dimmer	Dimmer 1	Dimmer 1	Dimmer
2		Dimmer 2	Dimmer 2	Dimmer Curve
3			Dimmer 3	Dimmer Response
4			Dimmer 4	Redshift

CH	7CH STROBE	9CH STANDARD (default)	12CH EXTENDED - 8bit	17CH EXTENDED - 16bit
1	Master Dimmer	Master Dimmer	Master Dimmer	Master Dimmer
2	Shutter	Shutter	Shutter	Master Dimmer Fine
3	Duration	Dimmer 1	Duration	Shutter
4	Dimmer 1	Dimmer 2	Dimmer 1	Duration
5	Dimmer 2	Dimmer 3	Dimmer 2	Dimmer 1
6	Dimmer 3	Dimmer 4	Dimmer 3	Dimmer 1 Fine
7	Dimmer 4	Dimmer Curve	Dimmer 4	Dimmer 2
8		Dimmer Response	Dimmer Curve	Dimmer 2 Fine
9		Redshift	Dimmer Response	Dimmer 3
10			Redshift	Dimmer 3 Fine
11			Effect	Dimmer 4
12			Device Settings	Dimmer 4 Fine
13				Dimmer Curve
14				Dimmer Response
15				Redshift
16				Effect
17				Device Settings

### 1CH DWE

CH	Function	Value	Setting	Remark	Default
1	Dimmer	000-255	0 - 100%		0

### 2CH DWE

CH	Function	Value	Setting	Remark	Default
1	Dimmer 1 (affects eye 1 + 3)	000-255	0 - 100%		0
2	Dimmer 1 (affects eye 2 + 4)	000-255	0 - 100%		0

### 4-1CH DWE

CH	Function	Value	Setting	Remark	Default
1	Dimmer 1	000-255	0 - 100%		0
2	Dimmer 2	000-255	0 - 100%		0
3	Dimmer 3	000-255	0 - 100%		0
4	Dimmer 4	000-255	0 - 100%		0

### 4-2CH DWE

CH	Function	Value	Setting	Remark	Default
1	Dimmer	000-255	0 - 100%		0
2	Dimmer Curve	000-51	No Function - Current Preset from Menu Settings		0
		052-101	Linear Dimmer Curve		
		102-152	Exponential Dimmer Curve		
		153-203	Logarithmic Dimmer Curve		
		204-255	S-Curve Dimmer Curve		
3	Dimmer Response	000-063	No Function - Current Preset from Menu Settings		0
		064-127	LED / fast		
		128-191	Medium		
		192-255	Halogen / slow		
4	Redshift	000-84	No Function - Current Preset from Menu Settings		0
		085-170	Redshift Off		
		171-255	Redshift On		

### 7CH STROBE MODE

CH	Function	Value	Setting	Remark	Default
1	Master Dimmer	000-255	0 - 100%		0
2	Shutter	000 - 019	Shutter close		20
		020 - 024	Shutter open		
		025 - 064	Strobe 1 (fast @ slow)		
		065 - 069	Shutter open		



2	Shutter	070 - 084	Strobe 2: opening pulse(fast ⊕ slow)		20
		085 - 089	Shutter open		
		090 - 104	Strobe 3: closing pulse(fast ⊕ slow)		
		105 - 109	Shutter open		
		110 - 124	Strobe 4: random strobe (fast ⊕ slow)		
		125 - 129	Shutter open		
		130 - 144	Strobe 5: random opening pulse (fast ⊕ slow)		
		145 - 149	Shutter open		
		150 - 164	Strobe 6: random closing pulse (fast ⊕ slow)		
		165 - 169	Shutter open		
		170 - 184	Strobe 7: burst pulse (fast ⊕ slow)		
		185 - 189	Shutter open		
		190 - 204	Strobe 8: random burst pulse (fast ⊕ slow)		
		205 - 209	Shutter open		
		210 - 224	Strobe 9: sine wave (fast ⊕ slow)		
		225 - 229	Shutter open		
		230 - 244	Strobe 10: burst (fast ⊕ slow)		
245 - 255	Shutter open				
3	Duration	000-255	0 - 100% (0ms - 510ms)	only affects to channel 2 - Strobe 1 025-064	0
4	Dimmer 1	000-255	0 - 100%		255
5	Dimmer 2	000-255	0 - 100%		255
6	Dimmer 3	000-255	0 - 100%		255
7	Dimmer 4	000-255	0 - 100%		255

#### 9CH STANDARD - 8bit (default)

CH	Function	Value	Setting	Remark	Default
1	Master Dimmer	000-255	0 - 100%		0
2	Shutter	000 - 019	Shutter close		20
		020 - 024	Shutter open		
		025 - 064	Strobe 1 (fast ⊕ slow)		
		065 - 069	Shutter open		
		070 - 084	Strobe 2: opening pulse (fast ⊕ slow)		
		085 - 089	Shutter open		
		090 - 104	Strobe 3: closing pulse (fast ⊕ slow)		
		105 - 109	Shutter open		
		110 - 124	Strobe 4: random strobe (fast ⊕ slow)		
		125 - 129	Shutter open		
		130 - 144	Strobe 5: random opening pulse (fast ⊕ slow)		

2	Shutter	145 - 149	Shutter open	20
		150 - 164	Strobe 6: random closing pulse (fast ⊕ slow)	
		165 - 169	Shutter open	
		170 - 184	Strobe 7: burst pulse (fast ⊕ slow)	
		185 - 189	Shutter open	
		190 - 204	Strobe 8: random burst pulse (fast ⊕ slow)	
		205 - 209	Shutter open	
		210 - 224	Strobe 9: sine wave (fast ⊕ slow)	
		225 - 229	Shutter open	
		230 - 244	Strobe 10: burst (fast ⊕ slow)	
		245 - 255	Shutter open	
3	Dimmer 1	000-255	0 - 100%	255
4	Dimmer 2	000-255	0 - 100%	255
5	Dimmer 3	000-255	0 - 100%	255
6	Dimmer 4	000-255	0 - 100%	255
7	Dimmer Curve	000-51	No Function - Current Preset from Menu Settings	0
		052-101	Linear Dimmer Curve	
		102-152	Exponential Dimmer Curve	
		153-203	Logarithmic Dimmer Curve	
		204-255	S-Curve Dimmer Curve	
8	Dimmer Response	000-063	No Function - Current Preset from Menu Settings	0
		064-127	LED / fast	
		128-191	Medium	
		192-255	Halogen / slow	
9	Redshift	000-84	No Function - Current Preset from Menu Settings	0
		085-170	Redshift Off	
		171-255	Redshift On	

### 12CH EXTENDED

CH	Function	Value	Setting	Remark	Default
1	Master Dimmer	000-255	0 - 100%		0
2	Shutter	000 - 019	Shutter close	20	
		020 - 024	Shutter open		
		025 - 064	Strobe 1 (fast ⊕ slow)		
		065 - 069	Shutter open		
		070 - 084	Strobe 2: opening pulse (fast ⊕ slow)		
		085 - 089	Shutter open		
		090 - 104	Strobe 3: closing pulse (fast ⊕ slow)		
		105 - 109	Shutter open		

2	Shutter	110 - 124	Strobe 4: random strobe (fast @ slow)		20
		125 - 129	Shutter open		
		130 - 144	Strobe 5: random opening pulse (fast @ slow)		
		145 - 149	Shutter open		
		150 - 164	Strobe 6: random closing pulse (fast @ slow)		
		165 - 169	Shutter open		
		170 - 184	Strobe 7: burst pulse (fast @ slow)		
		185 - 189	Shutter open		
		190 - 204	Strobe 8: random burst pulse (fast @ slow)		
		205 - 209	Shutter open		
		210 - 224	Strobe 9: sine wave (fast @ slow)		
		225 - 229	Shutter open		
		230 - 244	Strobe 10: burst (fast @ slow)		
		245 - 255	Shutter open		
3	Duration	000-255	0 - 100% (0ms - 510ms)	only affects to channel 2 - Strobe 1 025-064	0
4	Dimmer 1	000-255	0 - 100%		255
5	Dimmer 2	000-255	0 - 100%		255
6	Dimmer 3	000-255	0 - 100%		255
7	Dimmer 4	000-255	0 - 100%		255
8	Dimmer Curve	000-51	No Function - Current Preset from Menu Settings		0
		052-101	Linear Dimmer Curve		
		102-152	Exponential Dimmer Curve		
		153-203	Logarithmic Dimmer Curve		
		204-255	S-Curve Dimmer Curve		
9	Dimmer Response	000-063	No Function - Current Preset from Menu Settings		0
		064-127	LED / fast		
		128-191	Medium		
		192-255	Halogen / slow		
10	Redshift	000-84	No Function - Current Preset from Menu Settings		0
		085-170	Redshift Off		
		171-255	Redshift On		
11	Effect	000-40	No Function		0
		041-083	Effect 1 (slow to fast)		
		084-126	Effect 2 (slow to fast)		
		127-169	Effect 3 (slow to fast)		
		170-212	Effect 4 (slow to fast)		
		213-255	Effect 5 (slow to fast)		

12	Device Settings (please see remark *1)	000-029	No function		0
		030-034	Display Backlight On (hold 3s)		
		035-039	Display Backlight Off (hold 3s)		
		040-044	No function		
		045-049	DMX Fail Blackout (hold 3s)		
		050-054	DMX Fail Hold (hold 3s)		
		055-059	DMX Fail - Emergency Light (hold 3s)		
		060-064	No function		
		65-069	RAW (hold 3s)		
		070-074	User Calibrated (hold 3s)		
		075-079	No function		
		080-084	LED Frequency 800Hz (hold 3s)		
		085-089	LED Frequency 1200Hz (hold 3s)		
		090-094	LED Frequency 2000Hz (hold 3s)		
		095-099	LED Frequency 3600Hz (hold 3s)		
		100-104	LED Frequency 12kHz (hold 3s)		
		105-109	LED Frequency 25kHz (hold 3s)		
		110-114	No function		
		115-119	Fan Auto (hold 3s)		
		120-124	Fan Silent (hold 3s)		
		125-129	Fan Off (hold 3s)		
		130-134	Fan High Power (hold 3s)		
		135-139	No function		
		140-144	Invert Mapping Off (hold 3s)		
		145-149	Invert Mapping CW (hold 3s)		
		150-154	Invert Mapping CCW (hold 3s)		
		155-159	No function		
		160-164	LED Mode - Illumination (hold 1,5s)		
		165-169	LED Mode - Boost (hold 1,5s)		
		170-174	No function		
175-179	Factory Reset (hold 3s)				
180-184	User Reset (hold 3s)	no self-test by DMX			
185-255	No function				

#### 17CH EXTENDED

CH	Function	Value	Setting	Remark	Default
1	Master Dimmer	000-255	0 - 100%		0
2	Master Dimmer Fine	000-255	0 - 100%		0

3	Shutter	000 - 019	Shutter close		20
		020 - 024	Shutter open		
		025 - 064	Strobe 1 (fast ⊕ slow)		
		065 - 069	Shutter open		
		070 - 084	Strobe 2: opening pulse (fast ⊕ slow)		
		085 - 089	Shutter open		
		090 - 104	Strobe 3: closing pulse(fast ⊕ slow)		
		105 - 109	Shutter open		
		110 - 124	Strobe 4: random strobe(fast ⊕ slow)		
		125 - 129	Shutter open		
		130 - 144	Strobe 5: random opening pulse (fast ⊕ slow)		
		145 - 149	Shutter open		
		150 - 164	Strobe 6:random closing pulse (fast ⊕ slow)		
		165 - 169	Shutter open		
		170 - 184	Strobe 7: burst pulse (fast ⊕ slow)		
		185 - 189	Shutter open		
		190 - 204	Strobe 8: random burst pulse (fast ⊕ slow)		
		205 - 209	Shutter open		
		210 - 224	Strobe 9:sine wave (fast ⊕ slow)		
		225 - 229	Shutter open		
230 - 244	Strobe 10: burst (fast ⊕ slow)				
245 - 255	Shutter open				
4	Duration	000-255	0 - 100% (0ms - 510ms)	only affects to channel 2 - Strobe 1 025-064	0
5	Dimmer 1	000-255	0 - 100%		255
6	Dimmer 1 Fine	000-255	0 - 100%		255
7	Dimmer 2	000-255	0 - 100%		255
8	Dimmer 2 Fine	000-255	0 - 100%		255
9	Dimmer 3	000-255	0 - 100%		255
10	Dimmer 3 Fine	000-255	0 - 100%		255
11	Dimmer 4	000-255	0 - 100%		255
12	Dimmer 4 Fine	000-255	0 - 100%		255
13	Dimmer Curve	000-51	No Function - Current Preset from Menu Settings		0
		052-101	Linear Dimmer Curve		
		102-152	Exponential Dimmer Curve		
		153-203	Logarithmic Dimmer Curve		
		204-255	S-Curve Dimmer Curve		
14	Dimmer Response	000-063	No Function - Current Preset from Menu Settings		0
		064-127	LED / fast		
		128-191	Medium		
		192-255	Halogen / slow		

15	Redshift	000-84	No Function - Current Preset from Menu Settings		0
		085-170	Redshift Off		
		171-255	Redshift On		
16	Effect	000-40	No Function		0
		041-083	Effect 1 (slow to fast)		
		084-126	Effect 2 (slow to fast)		
		127-169	Effect 3 (slow to fast)		
		170-212	Effect 4 (slow to fast)		
		213-255	Effect 5 (slow to fast)		
17	Device Settings (please see remark *1)	000-029	No function		0
		030-034	Display Backlight On (hold 3s)		
		035-039	Display Backlight Off (hold 3s)		
		040-044	No function		
		045-049	DMX Fail Blackout (hold 3s)		
		050-054	DMX Fail Hold (hold 3s)		
		055-059	DMX Fail - Emergency Light (hold 3s)		
		060-064	No function		
		65-069	RAW (hold 3s)		
		070-074	User Calibrated (hold 3s)		
		075-079	No function		
		080-084	LED Frequency 800Hz (hold 3s)		
		085-089	LED Frequency 1200Hz (hold 3s)		
		090-094	LED Frequency 2000Hz (hold 3s)		
		095-099	LED Frequency 3600Hz (hold 3s)		
		100-104	LED Frequency 12kHz (hold 3s)		
		105-109	LED Frequency 25kHz (hold 3s)		
		110-114	No function		
		115-119	Fan Auto (hold 3s)		
		120-124	Fan Silent (hold 3s)		
		125-129	Fan Off (hold 3s)		
		130-134	Fan High Power (hold 3s)		
		135-139	No function		
		140-144	Invert Mapping Off (hold 3s)		
145-149	Invert Mapping CW (hold 3s)				
150-154	Invert Mapping CCW (hold 3s)				
155-159	No function				
160-164	LED Mode - Illumination (hold 1,5s)				
17	Device Settings (please see remark *1)	165-169	LED Mode - Boost (hold 1,5s)		0
		170-174	No function		
		175-179	Factory Reset (hold 3s)		
		180-184	User Reset (hold 3s)	no self-test by DMX	
		185-255	No function		

## 7.5 RDM Templates\*

The ROXX Show series features support for various RDM functions.

RDM (Remote Device Management) is a protocol enhancement to USITT DMX512 that allows bi-directional communication between the fixtures and the controller over a standard DMX line. This protocol will allow configuration, status monitoring and management.

You will need a RDM controller to get control over the supported parameters. See the tables below for supported RDM features.

Label:	ROXX CLUSTER B4 W
Model:	CLUSTER B4 W
Manufacturer:	ROXX
ID:	6A6Ah
Device ID:	201 xxxx

**ⓘ \*Note: During RDM identifying process CLUSTER B4 W flashes white alternately.**

### RDM functions

For easy identifying ROXX CLUSTER B4 W during RDM process the unit will strobe in white color.

PID	Function	Action	Values
0x00F0	DMX Start Adress	Set	001-512
0x00E0	DMX Personality	Set	7x DMX modes
0x00E1	DMX Slots	Read	n.a.
0x8001	Effect	Set	0= Stop Program / 1= Effect 1 / 2= Effect 2 / 3= Effect 3 / 4= Effect 4 / 5= Effect 5
0x8002	Effect Dimmer	Set	
0x8003	Effect Speed	Set	
0x8050	Master / Slave	Set	0= Master / 1= Slave
0x0500	Display Flip	Set	0= Off / 1= On
0x8051	Display Backlight	Set	0= Off / 1= On
0x8052	Display Lock	Set	0= Off / 1= On
0x8053	Startup Mode	Set	0= DMX / 1= AUTO / 2= Quick Light
0x8054	DMX Fail	Set	1= Hold / 2= Blackout / 3= Emergency
0x8055	Dimmer Curve	Set	1= Linear / 2= Exponential / 3= Logarithmic / 4= S-Curve
0x8056	Dimmer Response	Set	1= LED / 2= Medium / 3= Halogen
0x8057	Redshift	Set	0= Off / 1= On
0x8058	RAW Balance	Set	0= RAW / 1= User Calibrated
0x8024	User Calibration-White 1	Set	
0x8023	User Calibration- Amber 1	Set	
0x8020	User Calibration- Red 1	Set	
0x8029	User Calibration- White 2	Set	
0x8028	User Calibration- Amber 2	Set	
0x8025	User Calibration- Red 2	Set	
0x802E	User Calibration- White 3	Set	
0x802D	User Calibration- Amber 3	Set	
0x802A	User Calibration- Red 3	Set	

0x8033	User Calibration- White 4	Set	
0x8032	User Calibration- Amber 4	Set	
0x802F	User Calibration- Red 4	Set	
0x8059	LED Frequency (PWM)	Set	1= 800Hz / 2= 1200Hz / 3= 2000Hz / 4= 3600Hz / 5= 12kHz / 6= 25kHz
0x805A	Fan	Set	0= Auto / 1= Silent / 2= Fan Off / 3= Max. Power
0x805B	Invert Mapping	Set	0= Off / 1= CW / 2= CCW
0x805C	LED Mode	Set	0= Illumination / 1= Boost
0x805D	USB Update	Yes/No	0= No / 1= Yes
0x805E	Factory Reset	Yes/No	0= No / 1= Yes
0x805F	User Reset	Yes/No	0= No / 1= Yes
0x00C0	Firmware Version	read	n.a.
0x8700	Serial Number	Read	n.a.
0x0400	Device Power on Time	Read	n.a.
0x8701	Temperature LED 1	Read	n.a.
0x8702	Temperature LED 2	Read	n.a.
0x8703	Temperature LED 3	Read	n.a.
0x8704	Temperature LED 4	Read	n.a.
0x8705	LED 1 on Time	Read	n.a.
0x8706	LED 2 on Time	Read	n.a.
0x8707	LED 3 on Time	Read	n.a.
0x8708	LED 4 on Time	Read	n.a.



## Sensors

RDM enables various readouts for remote device monitoring. See the table below for sensors and sensor types. Please note: The RDM controller communicates with the fixtures to show only the available sensors for this fixture. The table is subject to change without notice.

Name	
Temperature	xx°C / xxx°F
Software Version	SW-Version
Errors	

## 8. TROUBLESHOOTING

Did you try turning the device off and on again?

Problem	Reason	Solution
Device is not responding.	No power.	Check cable connections and conform that power is switched on.
	Fuse defect.	Contact your qualified service technician / manufacturer.
Device has turned off.	Power failure or power was turned off.	Check power supply, fuse, connections, switches.
Device has stopped responding.	DMX cable correct?	Check cables.
Device operates strangely.	DMX cable inverted (pins correct?)	Use a phase inverter or different cables.
	DMX cable terminated?	If not, install DMX termination at the end of the cable.
	Stand Alone program running?	Stop internal Stand Alone.

## 9. MANUFACTURER'S DECLARATION

### Manufacturer's Warranty & Limitations of Liability

Please find our warranty conditions and limitations of liability inside our manufacturer's declaration at [www.roxxlight.com/support](http://www.roxxlight.com/support)

### Requesting Warranty-Service

To request warranty service for your product, please contact:

ROXX GmbH,

Hansestr. 91

51149 Köln

Email: [info@roxxlight.com](mailto:info@roxxlight.com) or the ROXX authorized reseller in your country, from where you purchased your product.

### Correct Disposal of this product



This is for the European Union and European countries with electrical waste collection systems. When this label is shown on the product or brochure it means that the item cannot be disposed with household waste. In order to prevent damage to the environment or human health please do not dispose this product uncontrolled. Make sure to act responsible, recycle this product separately from other types of waste to enable lasting reuse of resources. Private users please contact the retailer where you purchased this product or your local authorities to find out where and how proper recycling of this item is possible. Business users please contact your supplier or check the terms and conditions of your purchasing contract. Make sure not to mix this product with other commercial waste.

### FCC Statement

This device complies with Part 15 of the FCC Rules. Operation is subject to the following two conditions:

- (1) This device may not cause harmful interference, and
- (2) This device must accept any interference received, including interference that may cause undesired operation

NOTE: This equipment has been tested and found to comply with the limits for a Class B digital device, pursuant to Part 15 of the FCC Rules. These limits are designed to provide reasonable protection against harmful interference in a residential installation. This equipment generates, uses and can radiate radio frequency energy and, if not installed and used in accordance with the instructions, may cause harmful interference to radio communications. However, there is no guarantee that interference will not occur in a particular installation. If this equipment does cause harmful interference to radio or television reception, which can be determined by turning the equipment off and on, the user is encouraged to try to correct the interference by one or more of the following measures:

- Reorient or relocate the receiving antenna.
- Increase the separation between the equipment and receiver.
- Connect the equipment into an outlet on a circuit different from that to which the receiver is connected.
- Consult the dealer or an experienced radio/TV technician for help.

## CE Compliance

The equipment marketed by ROXX GmbH complies (where applicable) with the essential requirements and other specifications of the following Directives:

- 2014/30/EU (EMC)
- 2014/35/EU (LVD)
- 2011/65/EU (RoHS)

The complete EU- and UK-Declaration of Conformity can be found at [www.roxxlight.com/support](http://www.roxxlight.com/support), or you can also request it at [info@roxxlight.com](mailto:info@roxxlight.com)



