

**ROXX®**



**ROXX®**

Join the ROXXNATION

# We are **ROXX**<sup>®</sup>

## The name ROXX<sup>®</sup> came easily.

Combined with the concentrated knowledge and many years of experience, our three founders, who have been leaving their mark in the event and lighting industry for many years already, came together in 2019 to start this outstanding venture.

Product development, sales and marketing as well as the exceptional know-how and the profound rooting in the field of the professional lighting technology belong to our core competences and therefore guarantee extremely innovative and reliable products, excellent support and professional service in every aspect.



## Designed & developed in Germany

ROXX<sup>®</sup> products are developed and designed in Germany. Always in tight consultation with our customers and experts who will eventually be working with these tools. This ensures innovative, easy-to-use and performance-oriented solutions, which provide added value for our customers.



## Made to last

Recommended for permanent outdoor use, some ROXX® products feature additional corrosion protection and enhanced IP66 equipment protection, thereby providing that crucial extra for a wider range of applications. In addition to architectural or theme park applications, even fixed installations in coastal or offshore areas with high salt exposure can be reliably implemented over long periods of time.



---

<b>SHOW Series</b>	6
<b>SHOW mini</b>	8
B.SHOW mini	12
E.SHOW mini	14
T.SHOW mini	16
<b>SHOW</b>	18
E.SHOW	22
A.SHOW	24
<b>SHOW maxx</b>	26
E.SHOW maxx TW+	27
<b>Accessories</b>	28

---

<b>FLEX Series</b>	30
B.FLEX / B.FLEX mini	36
<b>Accessories</b>	37

---

<b>CLUSTER Series</b>	38
<b>CLUSTER S1</b>	40
<b>CLUSTER S2</b>	46
<b>CLUSTER Blinder</b>	54
B2 W / B4 W / B2 FC / B4 FC	58
<b>Mounting &amp; Rigging</b>	60
<b>Accessories</b>	62

---

<b>NEO Series</b>	64
-------------------	----

---

<b>ROXX.APP</b>	70
-----------------	----

---



Picture: © Christian Hedel



Picture: © Christian Hedel



Picture: © Yannis Kleibohm



Picture: © Timo Martens

# SHOW Series

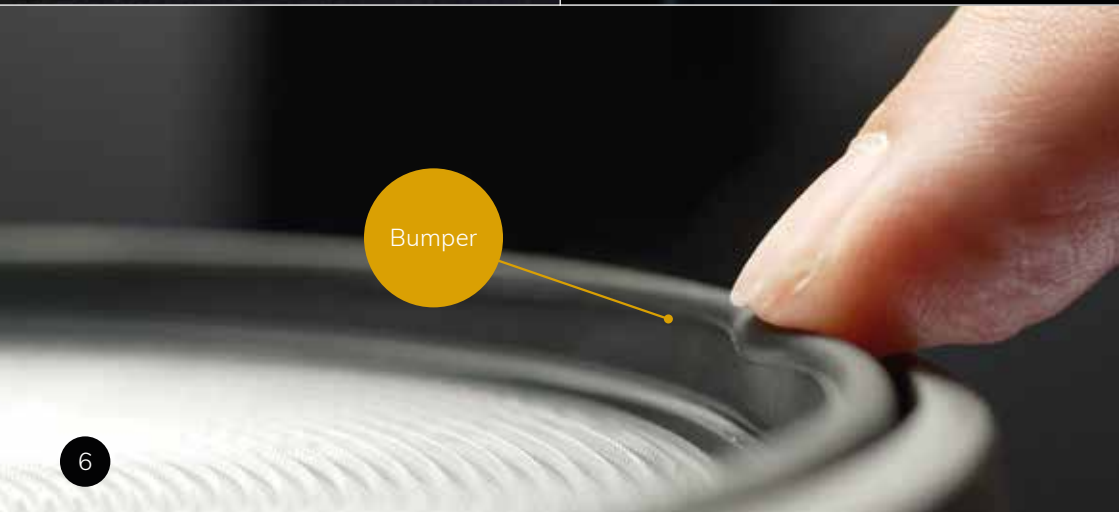
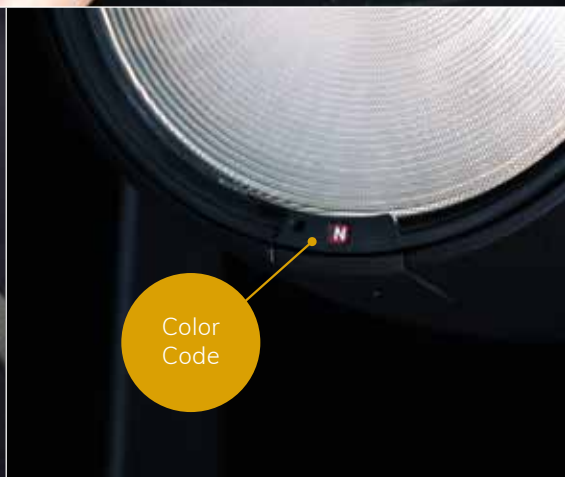
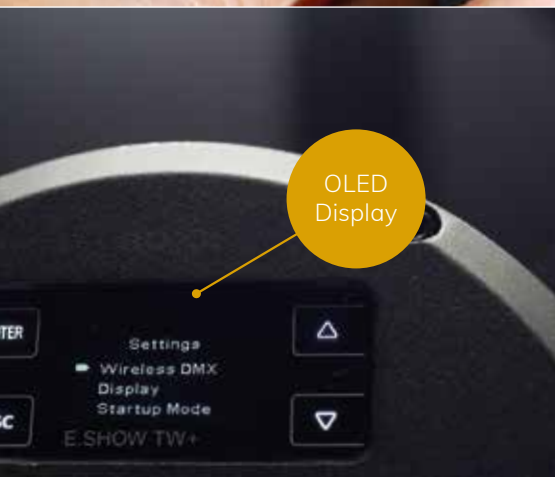



### **DMX / RDM**

Via two IP65-certified 5-pole XLR sockets, the fixture can be integrated into a wired DMX line and furthermore uses via bi-directional RDM communication.

## Everything under control

### **Wireless DMX**

ROXX® integrates the latest Wireless DMX technology from Swedish manufacturer Lumenradio.

The CRMX transceiver module integrated in our fixture realises wireless DMX reception as well as a separate transmission option.

### **Smart control via ROXX.APP**

The integrated Bluetooth interface enables direct control of the spotlights via ios device with ROXX.APP, without the need for additional hardware.

## Quick and easy. The lens change

Thanks to the specially developed and patented ROXX® R.LOK® technology, the lenses can be changed easily, quickly and without any tools. This allows the beam angle to be conveniently adjusted. The 360° slot rotation also allows the elliptical lenses to be aligned continuously.



# SHOW mini

**Kasalla, 2021**

E.SHOW mini







Picture: © Christian Hedel

With the SHOW mini series, ROXX® continues to fulfill the demand for very high performance, weatherproof lighting fixtures for entertainment and architectural applications, in addition to a major new addition, a battery version. The flexibility and variety of options previously offered in terms of light quality, size and accessories is now even more pronounced, giving customers that special extra bit of freedom of choice.

# SHOW mini



Size comparison  
between SHOW & SHOW mini





ROXX® SHOW mini Series uses Single-Source-LED's that provide a very smooth, powerful light without color- or multi-shadows and with LED variations including a Tunable White (+Color) and a RGB+Lime version. Circular as well as elliptical lenses can be changed easily, quickly and without any tools thanks to the specially developed and protected ROXX® R.LOK technology. A barndoor and honeycomb are also available as accessories.

 FULL COLOR	 DIMMING CURVES	 FLICKER-FREE	 RDM ENABLE	 IP65 RATED	 MASTER & SLAVE	 QUICKLIGHT FUNCTION	 OLED DISPLAY
 TUNABLE WHITE +	 16-BIT TECHNOLOGY	 COLOR CALIBRATION	 ETL Intertek	 STAND ALONE	 DIM TO WARM	 TEMPERATURE CONTROLLED FAN	 FC

# B.SHOW mini

## Battery version

Say goodbye to cable chaos with the new standard battery fixture for ultimate flexible usage without compromise. The powerful lithium-ion battery offers incredible versatility with up to 24 hours of runtime while ensuring reliable operation by preventing overcharging and exhaustive discharge. The integrated CRMX receiver module offers the latest wireless technology from Lumenradio and the fixture is ROXX.APP ready.



<b>B.SHOW mini TW+</b> Perfect whites & brilliant colors	<b>B.SHOW mini FC</b> Intense colors & variable white
Single-Source LED	Single-Source LED
60W / 6-color LED	60W / 4-color LED
3.000lm luminous flux	3.000lm luminous flux
CRI/Ra 97 / TLCI 98	CCT 2.000 - 10.000K
IP65 In/Outdoor	IP65 In/Outdoor
170 x 273 x 230mm	170 x 273 x 230mm
6,69 x 10,75 x 9,06 inches	6,69 x 10,75 x 9,06 inches
4,85 kg / 10,69 lbs	4,85 kg / 10,69 lbs



# E.SHOW mini

## Entertainment Version

The tool for stage, trade fair, theatre or film, now even more compact. The E.SHOW mini includes two LED versions, the already familiar Tunable White (RGBALC) and Full Color. Designed for indoor and outdoor use, the luminaire is IP65 certified and made of robust die-cast aluminium. In addition to control via DMX, RDM or standalone, ROXX® integrates the wireless technology of the Swedish manufacturer Lumenradio. The integrated Bluetooth interface enables direct control via an iOS device using ROXX.APP.



<b>E.SHOW mini TW+</b> Perfect whites & brilliant colors	<b>E.SHOW mini FC</b> Intense colors & variable white
Single-Source LED	Single-Source LED
100W / 6-color LED	100W / 4-color LED
4.500lm luminous flux	4.500lm luminous flux
CRI/Ra 97 / TLCI 98	CCT 2.000 - 10.000K
IP65 In/Outdoor	IP65 In/Outdoor
170 x 273 x 230mm	170 x 273 x 230mm
6,69 x 10,75 x 9,06 inches	6,69 x 10,75 x 9,06 inches
3,92 kg / 8,64 lbs	3,92 kg / 8,64 lbs



# T.SHOW mini

## Tracklight Version

The new tracklight from ROXX®, the T.SHOW mini, opens up another area of application for the compact Show mini series. Without compromising on performance or optics, the small quick-change artist adapts to all wishes and facilitates mounting and operation with its completely wireless control. The built-in LumenRadio W-DMX module or direct control via the iOS app, without additional hardware, allows for incredibly smooth and wireless operation.

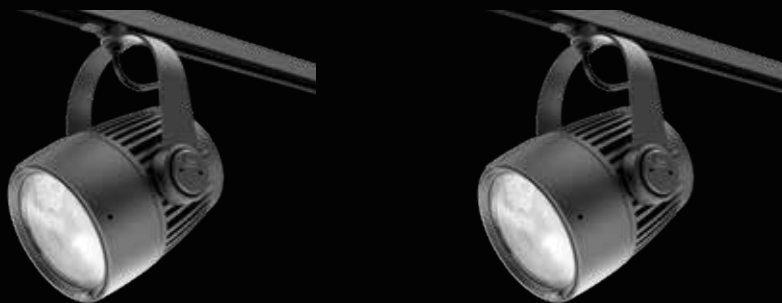

<b>T.SHOW mini TW+</b> Perfect whites & brilliant colors	<b>T.SHOW mini FC</b> Intense colors & variable white
Single-Source LED	Single-Source LED
100W / 6-color LED	100W / 4-color LED
4.500lm luminous flux	4.500lm luminous flux
CRI/Ra 97 / TLCI 95	CCT 2.000 - 10.000K
IP20 Indoor	IP20 Indoor
170 x 273 x 230mm	170 x 273 x 230mm
6,69 x 10,75 x 9,06 inches	6,69 x 10,75 x 9,06 inches
3,92 kg / 8,64 lbs	3,92 kg / 8,64 lbs



### **Full compatibility with all Show mini accessories**

Circular as well as elliptical Micro-Fresnel lenses can be changed easily, quickly and without any tools thanks to the specially developed and protected ROXX® R.LOK technology. A barndoor and honeycomb are also available as accessories and easily usable.



### **Turn your E.SHOW mini or B.SHOW mini into a Tracklight with the Tracklight Kit**

The Tracklight Kit consists of the Tracklight Yoke which is easily interchangeable with the standard yoke of the E.SHOW mini or the B.SHOW mini fixture. The simple and classic Pignose screws are also included in the kit and transform the lamp into a chic tracklight with a few simple steps.



# SHOW

**Seed, 2022**

E.SHOW FC



Picture: © Daniel Garcia



ROXX® SHOW Series satisfies the demand for very high performance, weatherproof lighting fixtures for entertainment and architectural applications, in terms of light quality, size and range of accessories.

# SHOW



Picture: © Timo Martens





## Entertainment & Architectural lighting

ROXX® SHOW Series uses Single-Source-LED's that provide a very smooth, powerful light without colour- or multi-shadow and with LED variations ranging from Tuneable White over RGB+Lime, to a pure Tungsten or Daylight version. Circular as well as elliptical lenses can be changed easily, quickly and without any tools thanks to the specially developed and protected ROXX® R.LOK® technology. This allows the beam angle to be adapted to the respective lighting situation. A barndoor, honeycomb, soft-box and anti-glare shield are available as accessories.

### ROXX® SHOW Series - the new benchmark.



# E.SHOW

## Entertainment Version

The daily tool for stage, trade show, corporate, theatre, broadcast or film. Designed both for indoor and outdoor use, the ROXX® E.SHOW series is IP65 certified and made from robust die-cast aluminium. In addition to control via DMX, RDM or standalone, ROXX® integrates the latest wireless technology from Swedish manufacturer Lumen-radio and thus already relies on the DMX Mesh™ technology. The integrated Bluetooth interface allows direct control via Apple tablet or Smartphone via unique ROXX.APP with no need for any additional hardware.



<b>E.SHOW TW+</b> Perfect whites & brilliant colors	<b>E.SHOW FC</b> Intense colors & variable white
Single-Source LED	Single-Source LED
200W / 6-color LED	230W / 4-color LED
9.000lm luminous flux	9.000lm luminous flux
CRI/Ra 97 / TLCI 98	CCT 2.000 - 10.000K
IP65 In/Outdoor	IP65 In/Outdoor
264 x 312 x 258 mm	264 x 312 x 258 mm
10,3 x 12,2 x 10,1 inches	10,3 x 12,2 x 10,1 inches
5,7 kg / 12,6lbs	5,7 kg / 12,6lbs



**Seed, 2022**  
E.SHOW FC

Picture: © Timo Martens



<b>E.SHOW T</b> Powerful warmwhite	<b>E.SHOW D</b> Powerful daylight
3.200K Tungsten LED	5.600K Daylight LED
200W	200W
11.000lm luminous flux	13.500lm luminous flux
CRI/TLCI 98	CRI/TLCI 98
IP65 In/Outdoor	IP65 In/Outdoor
264 x 312 x 258 mm	264 x 312 x 258 mm
10,3 x 12,2 x 10,1 inches	10,3 x 12,2 x 10,1 inches
5,7 kg / 12,6lbs	5,7 kg / 12,6lbs

# A.SHOW

## Architectural Version

For protection against environmental influences over a long period of time, the ROXX® A.SHOW series is IP66 certified and has an additional C5-M corrosion protection for coastal and offshore areas, providing that crucial extra for a wider range of applications. For comfortable and individual installation of the lighting fixtures, the external connections for power supply as well as the DMX inputs/outputs are designed as cable bushings with PG glands and Phoenix connection blocks.



<b>A.SHOW TW+</b> Perfect whites & brilliant colors	<b>A.SHOW FC</b> Intense colors & variable white
Single-Source LED	Single-Source LED
200W / 6-color LED	230W / 4-color LED
9.000lm luminous flux	9.000lm luminous flux
CRI/Ra 97 / TLCI 98	CCT 2.000 - 10.000K
IP66 In/Outdoor	IP66 In/Outdoor
231 x 311 x 258 mm	231 x 311 x 258 mm
9,1 x 12,2 x 10,2 inches	9,1 x 12,2 x 10,2 inches
6,1 kg (13,4lbs)	6,1 kg (13,4lbs)





<b>A.SHOW T</b> Powerful white	<b>A.SHOW D</b> Powerful daylight
3.200K Tungsten LED	5.600K Daylight LED
200W	200W
11.000lm luminous flux	13.500lm luminous flux
CRI/TLCI 98	CRI/TLCI 98
IP66 In/Outdoor	IP66 In/Outdoor
231 x 311 x 258 mm	231 x 311 x 258 mm
9,1 x 12,2 x 10,2 inches	9,1 x 12,2 x 10,2 inches
6,1 kg (13,4lbs)	6,1 kg (13,4lbs)

# SHOW maxx

The new E.SHOW maxx expands the SHOW series by adding a 800W luminaire with perfect whites and brilliant colors. The new fixture has an integrated accessory holder and a „one-hand lens system“.

It features currentless presettings, an optimized rigging bracket, has an integrated CRMX transmit and receive function as well as being ROXX.APP ready.



- + Integrated handle
- + Color coated lens handle
- + Safety-free lens system
- + Cable guide
- + One-sided tilt knob
- + Integrated camlocks
- + TV spigot holes
- + Tilt scale





### **E.SHOW maxx TW+**

Perfect whites & brilliant colors

Single Source LED	IP65 In/Outdoor
800W / 6-color LED	350 x 280 x 450mm
Integrated accessory holder	13,78 x 11,02 x 17,72 inches
CRI/Ra 97 / TLCI 95	13,5 kg (29,76lbs)



# SHOW Series / Accessories

## SHOW / SHOW mini



**Available for all products of the SHOW Series**  
Cases and Omega brackets

### Safety Free Accessory Holder

A.SHOW, E.SHOW, SHOW mini

Is only placed on the luminaire when needed and otherwise is concealed in the case.

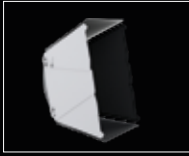

### Safety Free Barndoor

A.SHOW, E.SHOW, SHOW mini

A 360° rotatable 8-bladed barndoor is available for optimal beam control.



### Safety Free Honeycomb

A.SHOW, E.SHOW, SHOW mini

A honeycomb filter is available to limit stray light and lateral reflections.

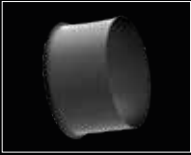

### Safety Free Full Anti-Glare Shield

A.SHOW, E.SHOW

Prohibits the direct view of the LED and thus reduces glare and stray light to a minimum



### Lenses

A.SHOW, E.SHOW, SHOW mini

Circular and elliptical lenses. The 360° slot rotation also allows the elliptical lenses to be aligned continuously.



### Suspended Luminaire

E.SHOW, A.SHOW, SHOW mini

The handle is removed and the mounting points are simply closed with the caps provided.



### DoPchoice® Snapbag

A.SHOW, E.SHOW

For an absolutely even illumination of motifs in camera applications.

## SHOW mini



### Tracklight Kit

E.SHOW mini, B.SHOW mini

Consists of the Tracklight Yoke and two Pignose screws to transform your fixture into a tracklight.

### Pignose Screws

E.SHOW mini, B.SHOW mini, T.SHOW mini

For a more elegant look and additional protection against unintentional adjustment of inclination.

## SHOW maxx

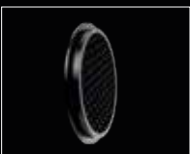

### Lenses

SHOW maxx

Circular and elliptical lenses. Quick installation with color coated lens handle.

### PO Yoke

SHOW maxx

Including 28mm junior pin

### Floor Extension

SHOW maxx

with the floor extension the E.SHOW maxx TW+ can also be used as floor application

### Safety Free Barndoor

SHOW maxx

A 360° rotatable 8-bladed barndoor is available for optimal beam control.

### Safety Free Honeycomb

SHOW maxx

A honeycomb filter is available to limit stray light and lateral reflections.

### Grid Holder & Half Grids (Single & Double)

SHOW maxx

For live broadcasts, interviews, or studio productions, the Half Grids provide impeccable lighting control for television professionals.

# FLEX Series

**German Sustainability Award, 2022**

B.FLEX, FLEX HAT



Picture: © Svrtson Design



One central high power LED, in combination with twentyfour ultra-bright SMD LEDs create amazing, bi-color effects in wall-wash and deco-light applications.

**Battery Operated for 100% Flexibility**

Long-life, powerful lithium-ion battery guarantees reliable operation up to 24 hours runtime and 100% flexibility on any event. The integrated Battery Management System prevents overcharging and exhaustive discharge. An additional charging setup protects the battery during longer storage and thus ensures a longer service life.

# FLEX Series

## ROXX® specially developed Dual-Bayonet-System

Due to our special designed dual-bayonet system all our one-size accessories like holographic filters, glare-shields or creative adaptors such as FLEX Light Tubes and HAT can be combined and fit tool-free to all FLEX models.



## Halo EFX Engine

One central high power LED, in combination with twentyfour ultra-bright SMD LEDs create amazing, bi-color effects in wall-wash and deco-light application. Due to its single pixel control, ROXX® HALO EFX engine allows advanced and creative effect possibilities and a stunning eye-candy look. The versatile tool for wall-wash, bi-color and pixel effects. The individual LED's can be controlled by any DMX source, or by using our internal pre-programmed Macro patterns and chasers.





### **Ingenious 2in1, fan-free cooling system for a clean and unique design**

The specially designed Copper Heat pipe cooling system of the FLEX Series is a highly thermally conductive heat pipe with a special capillary structure and liquid inside. The liquid absorbs the heat generated by the LED, heats up and migrates in vapor form to the other end of the heat pipe, where it cools down again due to the low temperature prevailing there and thus condenses. This continuous cycle creates a kind of water cooling, which gives the FLEX Series a silent and at the same time very effective and efficient heat dissipation.



### **Diffusors**

Thanks to the inner bayonet, filters can be changed easily, from native 3° to circular 5°, 10°, 20°, and elliptical 5°x20° or 5°x30°.

# FLEX Series

## Light Tubes

The 6 different sized, white light tubes can be attached to the FLEX series, creating stunning deco effects. Combining the two light sources will create spectacular fading colors or fire effects, due to the different radiation angles. Also, the combination of different tube lengths allows lighting designers a lot of creativity.





## PRO AV AWARD, 2022

Picture: © Manfred H. Vogel

### FLEX Serie, FLEX HAT

#### FLEX HAT

The perfect accessory for Gala dinner tables or glare free outdoor light applications. Due to it's special designed reflector the lightthrowing diameter reaches around 2m, ideal for table illumination while showing a nice deco effect at the same time, due to the mix between reflections and shadings.

*„The high-quality appearance of the „HAT“ allows me to use the luminaires in close proximity to the audience and therefore include the spectator even more closely in the action and let them become part of the light show.“*

*Flo Erdmann ,  
Freelance lightdesigner*



# FLEX Series



<b>B.FLEX</b>	<b>B.FLEX mini</b>
Battery Operated	Battery Operated
40W RGBL Spotlight	15W RGBL Spotlight
Color: Black	Color: Black
ROXX.APP ready	ROXX.APP ready
IP65 / Wireless DMX	IP65 / Wireless DMX
120 x 200 x 120mm	120 x 140 x 120mm
4,72 x 7,87 x 4,72 inches	4,72 x 5,51 x 4,72 inches
2,49 kg (5,49lbs)	1,49 kg (3,28lbs)
CRI/Ra: 88	CRI/Ra: 88
2.000-10.000K	2.000-10.000K



### **FLEX HAT**

The perfect accessory for Gala dinner table or glare free outdoor light applications. Designed for tables with a diameter of 2 m.



### **Hoodie**

The hoodie turns every FLEX fixture into an individual design piece.



### **Yoke**

Base for FLEX to be used as a tiltable floor stand or as an accessory for rigging, using a 13mm (½ inch) centric and oblong hole.

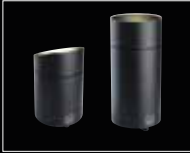

### **Anti-Glare Shield**

Full-Anti-Glare-Shield and Half-Anti-Glare-Shield for precise control of the glare.



### **Diffusors**

Thanks to the inner bayonet, filters can be changed easily, from native 3° to circular 5°, 10°, 20°, and elliptical 5°x20° or 5°x30°.

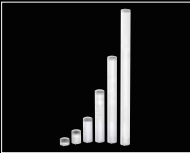

### **Tubes**

Opal acrylic tubes in 6 different lengths for ambient two-tone effects, fire effect and so much more. The FLEX Tubes include a bayonet ring and a lid. FLEX tubes fit all FLEX models.



### **Base Extension**

A base to be attached underneath FLEX when using cabled DMX for upright positioning.



### **Groundplate**

Base used as counterweight for the longer tubes, includes leveling screws on all sides. An integrated spirit level serves for quick and convenient tilt adjustment.

### **Connectionplate**

Due to its 3x 3/8" female thread it allows for attaching multiple accessories such as FLEX Spike, universal microphone stands and bolts.

# CLUSTER Series

Scorpions, Rock Believer Tour  
CLUSTER B4FC



Picture: © Manfred Nikitser



All CLUSTER products can be easily connected both horizontal and vertically, by using the integrated C-Lok system. The series is made to enable toolless multiple array configurations, scalable from a single vertical line, to massive matrix like arrays. All products are outdoor ready and protected from ingress of dust and rain, thanks to their IP65 rating. There are several mounting options – Camlock mounts on top and back enable the use of Omega-Brackets, Yokes can be attached to mounting points on all sides, or the internal C-Lok system can be used for seamless interconnection. Pre-Link Magnets on top and side help to align the fixtures, giving an incredible user-friendly operation and save interlocking. A specially designed rigging bracket is used for seamless connection of multiple CLUSTER products, to avoid gaps due to bracing of the truss structure by variable, sliding mounting positions. Floor extensions can be used to create vertical structures in single or double rows.

# CLUSTER S1

Featuring 720 RGB LEDs and 288 CW LEDs, the CLUSTER S1 delivers a massive output that captivates any audience. With 26 controllable segments on both RGB and individual strobe lines, you have unparalleled control over your lighting environment. Designed for convenience and performance, the S1 comes equipped with a plethora of features and allows you to choose from a vast library of built-in patterns for effortless creation of stunning effects.

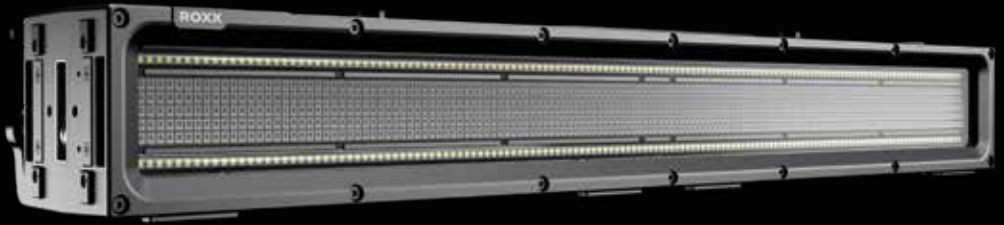

- + High-power, pixel-mappable hybrid strobe / wash
- + Each 26x controllable segments on RGB and individual strobe lines
- + 720 x RGB LED's & 288 x CW LED's creating massive output
- + Continuous pixel pitch of all LED lines between the devices CLUSTER S1 and S2
- + Large number of build-in patterns for fast and simple way of creating stunning effects
- + IP65 rated for Indoor & Outdoor use
- + Integrated C-Lok system for toolfree and seamless CLUSTER setups
- + Pre-Link Magnets for easy aligning and "one-handed" operation
- + Optional magnetic filters enable distinctive effects in every light show and camera application
- + Multiple mounting locations for creative rigging options & floor mount
- + 16-bit dimming control for smooth, perfect fades
- + Adjustable PWM frequencies up to 25kHz guarantee flicker-free camera operation



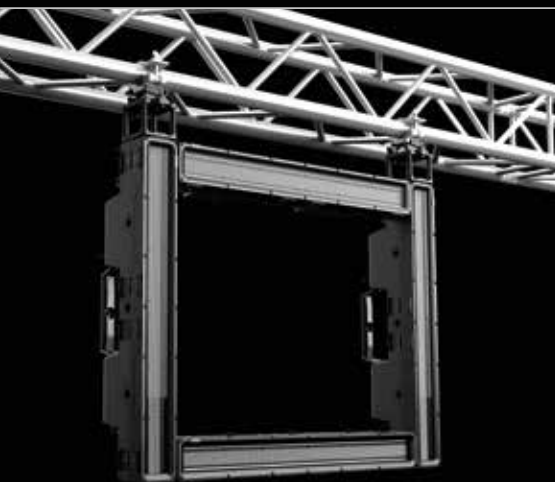

# CLUSTER S1

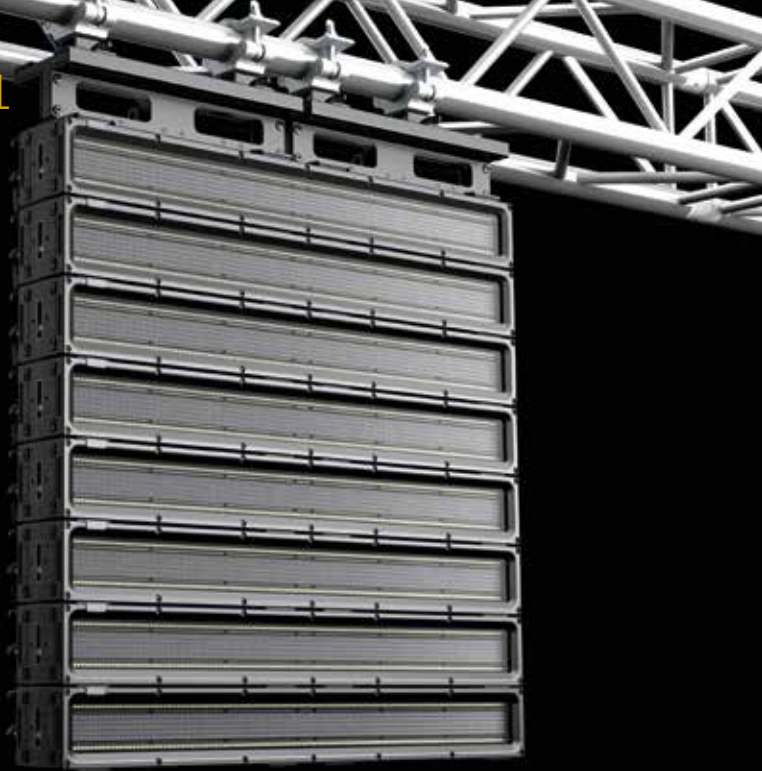

CLUSTER S1	
288x CW LED's (7000K)	12,84kg / 28,31lbs
720x RGB LED's	800 x 100 x 182,5mm
C-Lok Cluster System	31,49 x 3,93 x 7,19 inches
Magnetic Pre-Link System	Max power consumption 1.010W
2000-10.000K	



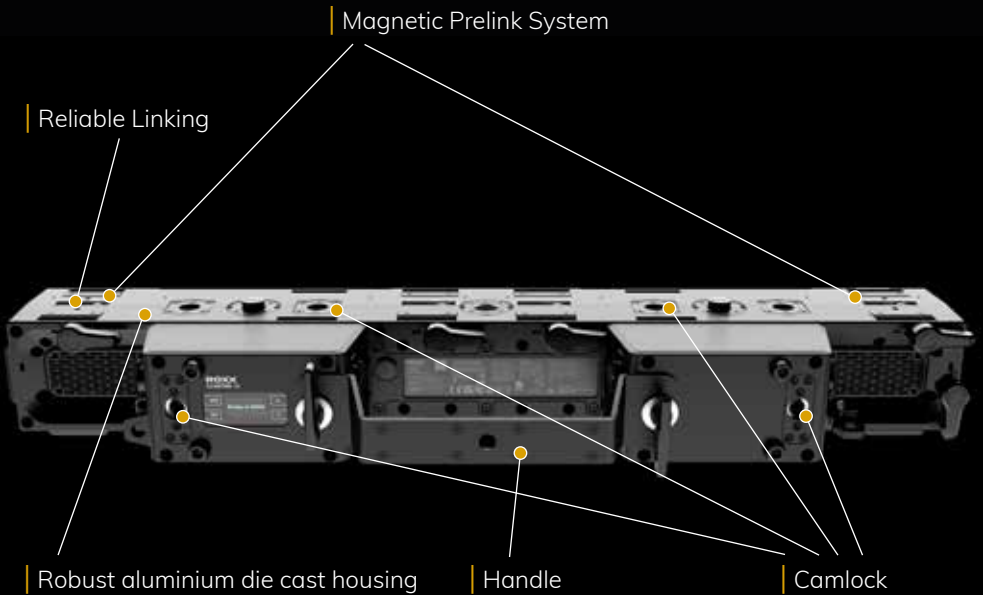

- + True1 compatible Power I/O
- + 5-Pin DMX I/O
- + USB socket for easy firmware update
- + Ethernet male/female for Artnet & sACN
- + OLED Display with backlit controls
- + Toolfree C.LOK system
- + Camlock fasteners



# CLUSTER S1

Enhance your visual repertoire with optional magnetic filters, enabling distinctive effects tailored to every light show and camera application. With multiple mounting locations, including creative rigging options and floor mounting, the S1 offers incredible flexibility in setup.

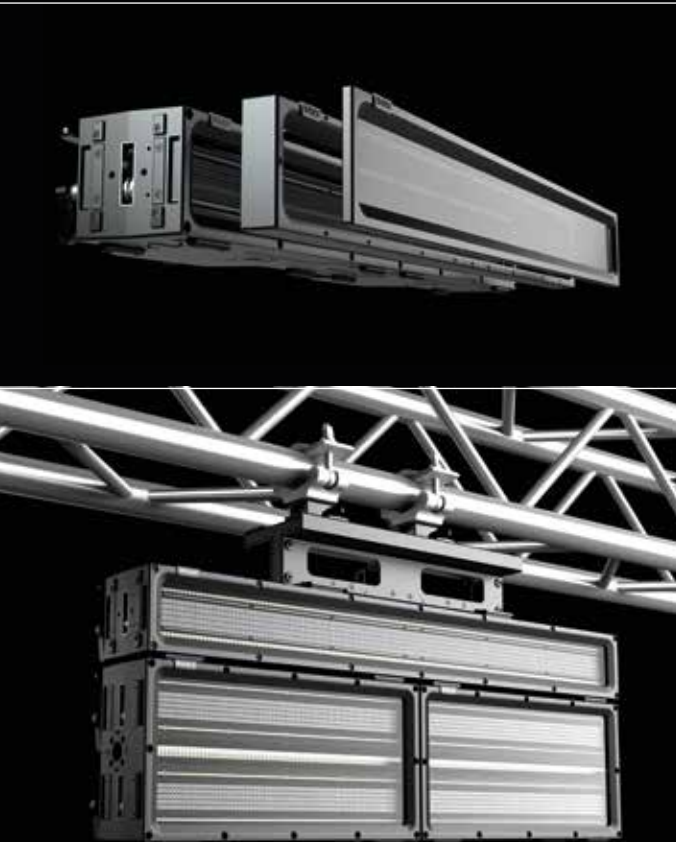
Enjoy smooth, perfect fades with 16-bit dimming control, while adjustable PWM frequencies up to 25kHz guarantee flicker-free camera operation, ensuring your visuals remain flawless in any recording scenario.



Experience seamless transitions and breathtaking effects with the continuous pixel pitch between CLUSTER S1 and S2 devices.

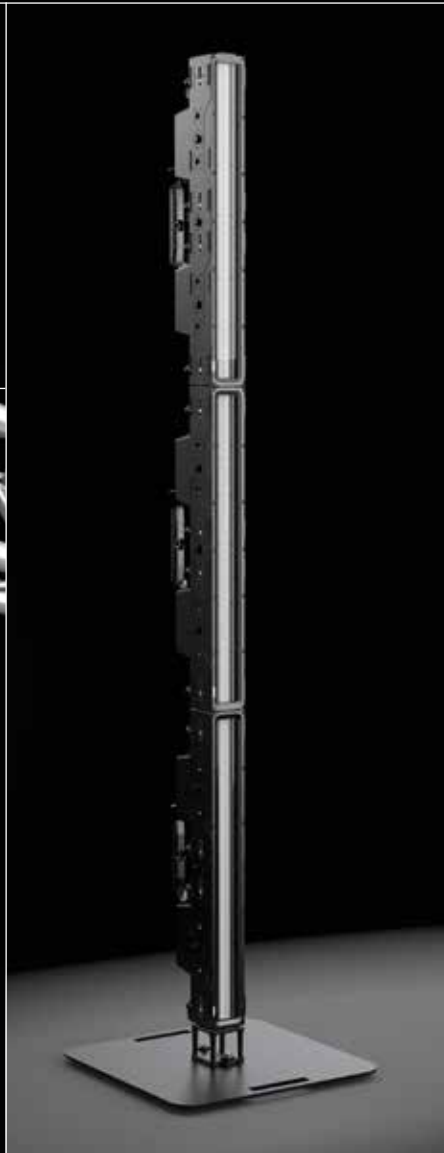

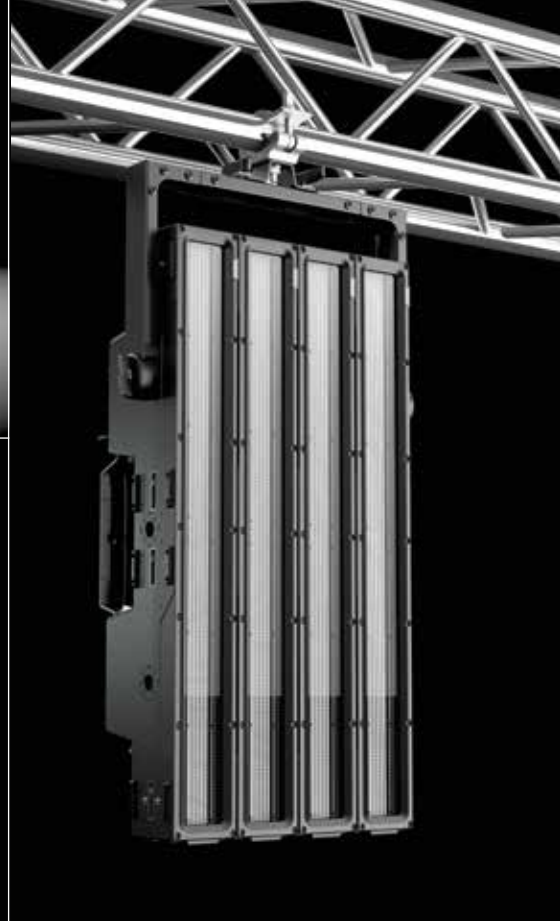

Whether indoors or outdoors, the IP65 rating ensures reliable operation in any environment. Say goodbye to cumbersome setups with the integrated C-Lok system, allowing for tool-free and seamless CLUSTER configurations. Pre-Link Magnets simplify alignment and operation, enabling you to focus on unleashing your creativity.

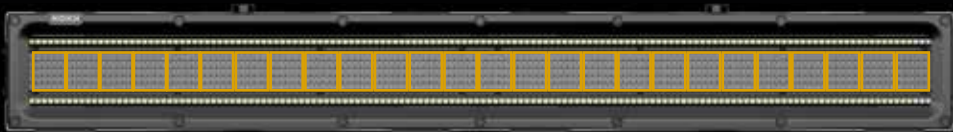

**RGB Panel**

Total 720 x RGB LED's, each controllable in 26 segments

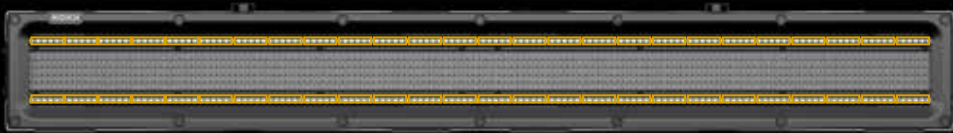

**Single High-Power Strobe Lines**

Two 144x High Power Cold-White LEDs, total 288x Cold-White LED's  
Controllable in 26 segments

# CLUSTER S2



Picture: © Matthew Goodyear/ Louder UK





**Pendulum, 2023**  
CLUSTER S2

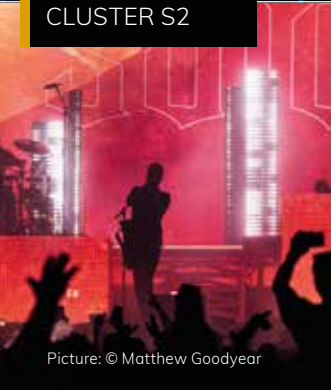

Picture: © Matthew Goodyear

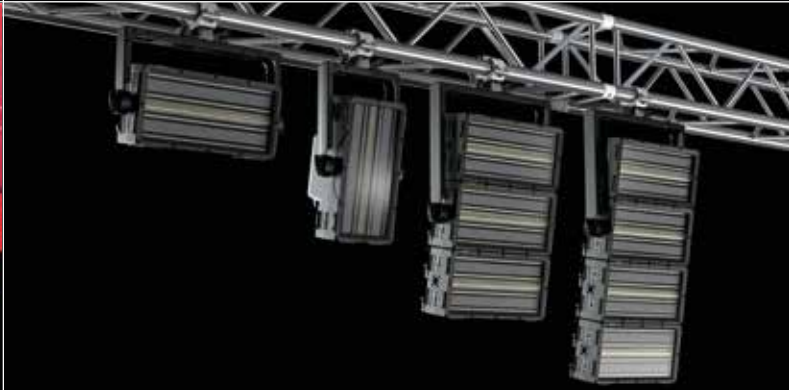

## CLUSTER S2

All CLUSTER products can be easily interconnected both horizontally and vertically, by using the integrated C-Lok system. The series is made to enable toolless multiple array configurations, scalable from a single vertical line to massive matrix like arrays. The S2 is an advanced pixel mappable strobe and washlight that combines two complementary effects in one unit, designed for extremely powerful and versatile applications. Thanks to the advanced and tool-free cluster mechanism, the fixture can be combined with all CLUSTER series products to provide lighting designers with new creative possibilities in horizontal and vertical configurations and is suitable for small to large venues and stadiums.



CLUSTER S2 features a large number of build-in patterns, giving users a fast and simple way of creating stunning effects whenever a media server is not available, or the installation requires a speedy solution.





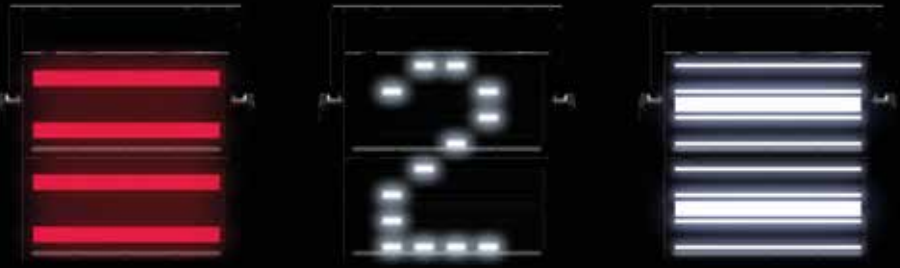

With our ROXX CLUSTER System and the equal spacing of the individual LED lines, continuous effects can be displayed across several units. In this way, the units merge into a large whole in both horizontal and vertical alignment. The 4 individual, thin strobe lines can also be used to display numbers, letters and graphics.

- + High-power, pixel-mappable hybrid strobe / wash
- + Center Strobe mimics traditional look from Xenon-bulb
- + Full color mixing & tuneable white with high CRI
- + Four extra single Strobe lines creating unique effects and giving extra boost on High-Power Strobe applications
- + Large number of build-in patterns for fast and simple way of creating stunning effects
- + IP65 rated for Indoor & Outdoor use
- + Flexible Interlocking system for truss/ floor mount
- + C-Lok for seamless CLUSTER setups
- + Multiple mounting locations for creative rigging options
- + Including Yoke
- + 16-bit dimming control for smooth, perfect fades
- + Easy to use OLED display with touch-sensitive and backlit controls
- + Adjustable PWM frequencies up to 25kHz guarantee flicker-free camera operation

# CLUSTER S2



CLUSTER S2	
612x CW LED's (7000K)	12,6 kg (27,78lbs)
680x RGB LED's	CRI/Ra: 88
C-Lok Cluster System	Luminous flux: 70.600lm
Magnetic Pre-Link System	Max power consumption 1.250W
2000-10.000K	
400 x 200 x 191mm	
15,75 x 7,87 x 7,52 inches	





- + True1 compatible Power I/O
- + 5-Pin DMX I/O
- + USB socket for easy firmware update
- + Ethernet male/female for Artnet & sACN
- + OLED Display with backlighting controls
- + Toolfree C.LOK system
- + Camlock fasteners

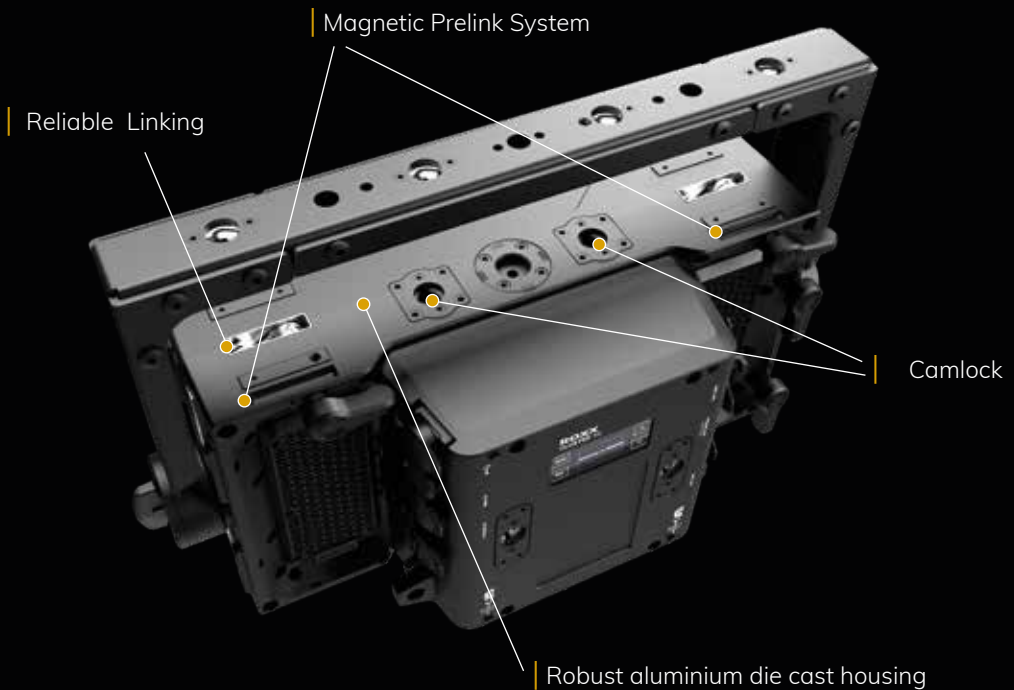

# CLUSTER S2

ROXX also offers a wide range of magnetic, easy-to-apply accessory filters. The smoked clear filter is especially useful in TV applications, as it allows the devices to visually disappear in the stage design when switched off. The two elliptical filters shape the light beam either vertically or horizontally with a frost effect, giving users even more effect possibilities.



FX Filter Elliptical Horizontal



FX Filter Elliptical Vertical



FX Filter Smoked Clear



FX Distance Frame



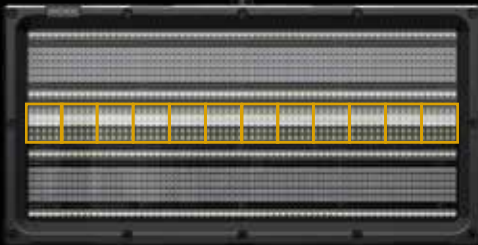

### **High-Power Center Strobe Line**

340 x High-Power Cold-White LED's  
Controllable in 12 segments

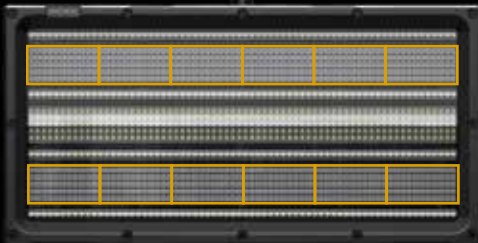

### **RGB Panels**

Each 340 x RGB LED's  
Total 680 x RGB LED's  
Each controllable in 6 segments

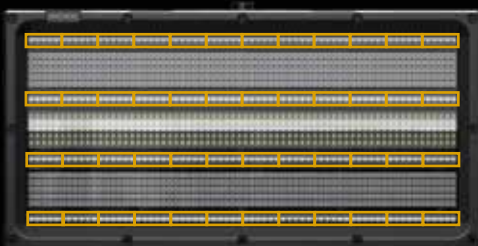

### **Single High-Power Strobe Lines**

Four 68x High Power Cold-White LEDs  
Total 272 x Cold-White LED's  
Controllable in 12 segments

# CLUSTER Blinder

Rock am Ring, Mandora Stage  
CLUSTER B2W / B4W

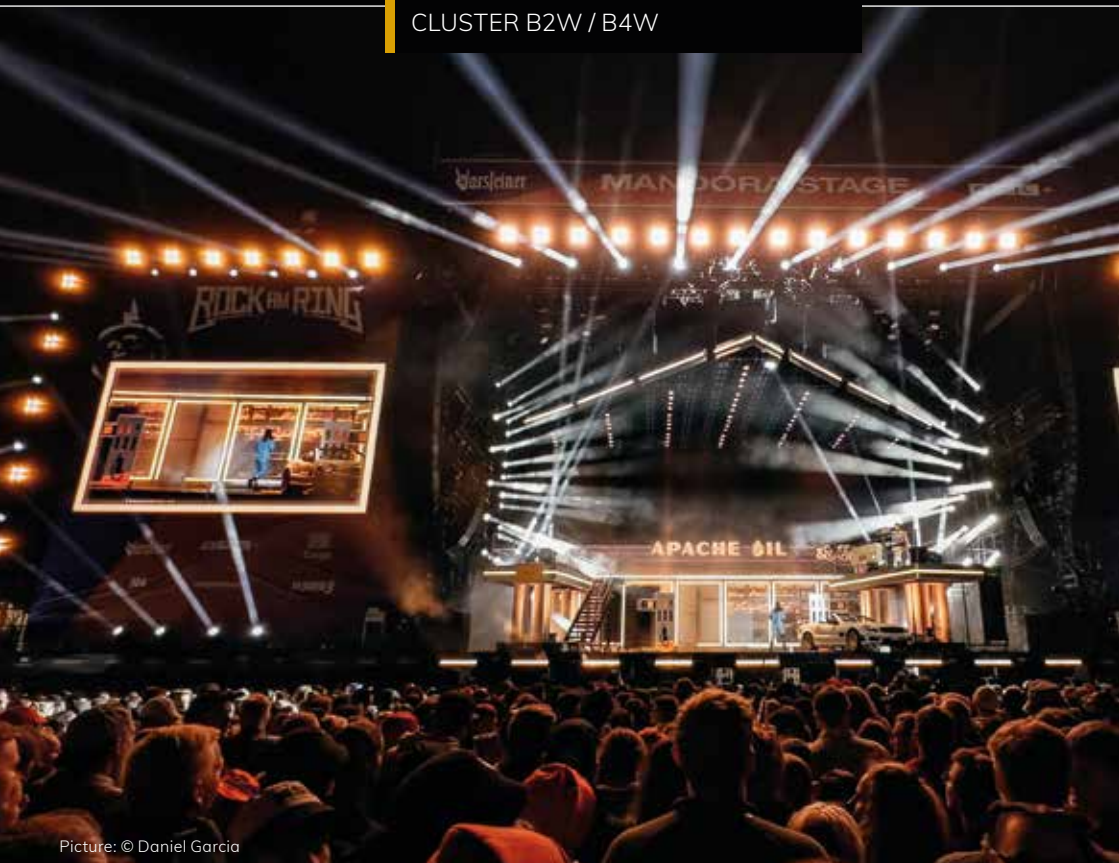

Picture: © Daniel Garcia



Picture: © Clive Bailey



**Glastonbury, Pyramid Stage**  
CLUSTER B4W

Picture: © Getty Images

# CLUSTER Blinder

ROXX® Audience Blinders are available as 2-lite or 4-lite individually adjustable pods, in either a Warmwhite- or Full-Color-version.



- + 2-lite or 4-lite Audience Blinder, Strobe, Wash
- + IP65 rated for Indoor & Outdoor use
- + Being almost twice as bright while consuming 60% less power compared to a conventional DWE blinder
- + Emulated “shift to warm” to mimic incandescent fixtures
- + Individually controllable Pods for stunning pixel effects
- + Integrated C-Lok system for toolfree and seamless CLUSTER setups
- + Pre-Link Magnets for easy aligning and “one-handed” operation
- + Multiple mounting locations for creative rigging options & floor mount
- + 16-bit dimming control for smooth, perfect fades
- + Four selectable dimmer curves with adjustable response
- + Adjustable PWM frequencies up to 25kHz guarantee flicker-free camera operation
- + Individual pan of each pod to allow for directional adjustments



Robust aluminium die cast housing

Magnetic prelink system

Camlock

Reliable linking

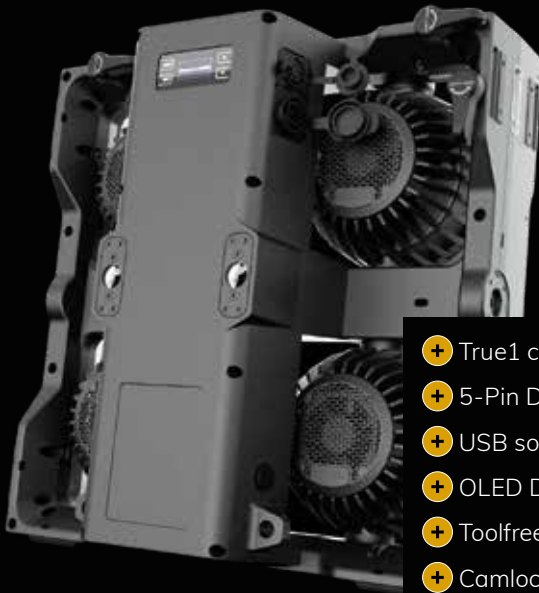

- + True1 compatible Power I/O
- + 5-Pin DMX Out
- + USB socket for easy firmware update
- + OLED Display with backlit controls
- + Toolfree C.LOK system
- + Camlock fasteners

# CLUSTER Blinder

## Warmwhite

In the Warmwhite version, an emulated 'shift to warm' effect warms the color temperature of the light as it dims. To deliver a perfect classic tungsten look, Amber and Red LED's are mixed with the high-power Warmwhite LED's when decaying.

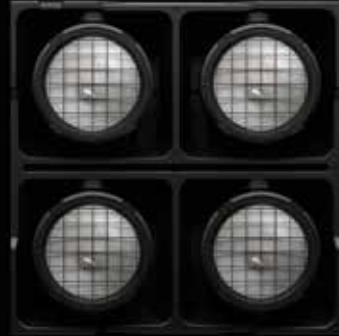

CLUSTER B2 W	CLUSTER B4 W
2 x 300W White	4 x 300W White
Warm White + Amber + Red LEDs	Warm White + Amber + Red LEDs
21.000lm luminous flux	35.000lm luminous flux
C-Lok Cluster System	C-Lok Cluster System
Magnetic Pre-Link System	Magnetic Pre-Link System
400 x 200 x 191mm	400 x 400 x 191mm
15,75 x 7,87 x 7,52 inches	15,75 x 15,75 x 7,52 inches
10,5 kg (23,15lbs)	16,2 kg (35,71lbs)
CRI/Ra: 80	CRI/Ra: 80
Max power consumption 650W	Max power consumption 1.350W

## Full Color

The Full Color version reproduces the same look by using its warmwhite LED's in combination with RGB and Amber, plus the full range of user adjustable color mixing and tunable white.



<b>CLUSTER B2 FC</b>	<b>CLUSTER B4 FC</b>
2 x 300W Full Color	4 x 300W Full Color
RGBA + Warm White LEDs	RGBA + Warm White LEDs
16.000lm luminous flux	28.000lm luminous flux
C-Lok Cluster System	C-Lok Cluster System
Magnetic Pre-Link System	Magnetic Pre-Link System
400 x 200 x 191mm	400 x 400 x 191mm
15,75 x 7,87 x 7,52 inches	15,75 x 15,75 x 7,52 inches
10,5 kg (23,15lbs)	16,2 kg (35,71lbs)
CRI/Ra: 90	CRI/Ra: 90
Max power consumption 620W	Max power consumption 1.250W

# CLUSTER Series

## Mounting & Rigging

All CLUSTER products can be easily interconnected both horizontally and vertically, by using the integrated C-Lok system. The series is made to enable tool-free multiple array configurations, scalable from a single vertical line to massive matrix-like arrays.

### Mounting Options

There are several mounting options – Camlock mounts on top and back enable the use of Omega-Brackets, Yokes can be attached to M12 mounting points on all sides, or the internal C-Lok system can be used for seamless interconnection. Pre-Link Magnets on the top and sides help to align the fixtures, giving 'hands free' operation for secure interlocking.

### Rigging Bracket

A specially designed rigging bracket is used for a seamless connection of multiple Blinders as well as to avoid gaps due to bracing of the truss structure by variable, sliding mounting positions.

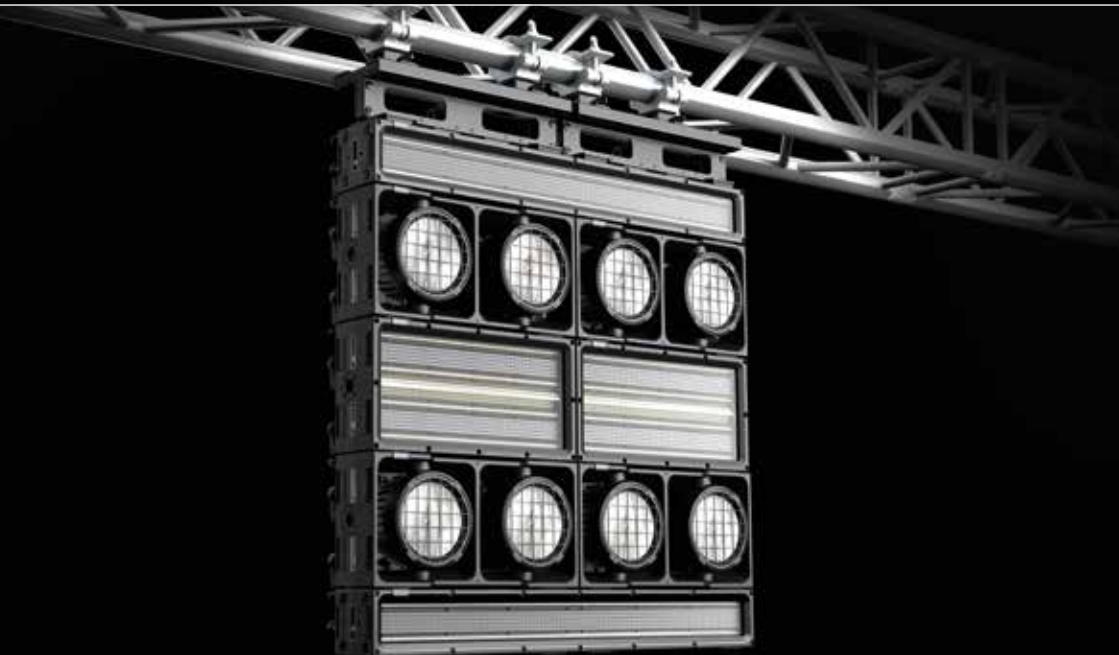

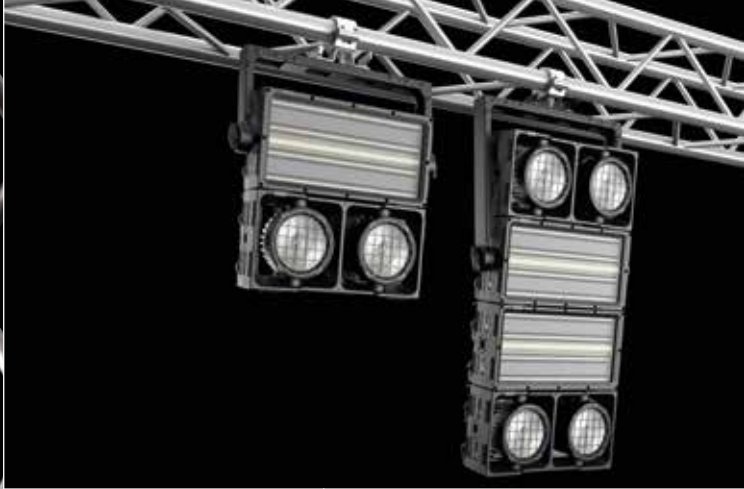
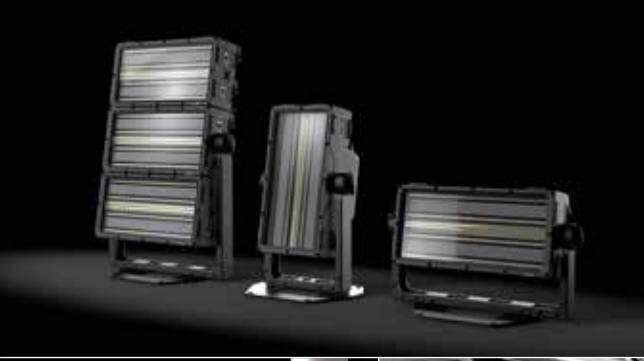

## **CLUSTER Yokes**

CLUSTER Yoke 4.2 is included in the 4-Lite version of the CLUSTER Blinder. CLUSTER Yoke 4.1 is included in the 2-Lite version and CLUSTER S2.



# CLUSTER Series / Accessories



## CLUSTER Yoke 4.2, 4.3, 2.2

Is only placed on the luminaire when needed and otherwise is concealed in the case. Allows vertical rigging and floor mounting.

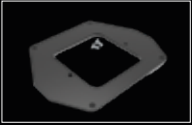

## CLUSTER Floor Extension

With its integrated rubber feet it's designed to ensure a secure stand on every plane surface with every possible angle / orientation of the fixtures head.



## CLUSTER Omega Bracket

Tool-free and fast mounting via ¼ turn fasteners. Suitable for all Cluster models.



## CLUSTER Rigging Bracket G2

Used for seamless connection of multiple CLUSTER units to avoid gaps due to bracing of the truss structure by variable, sliding mounting positions.



## Floor Bracket

For horizontal use on the ground with the option of setting different angles.



## Vertical Bracket

### CLUSTER S1

For column application on the floor or as vertical suspension application.



## CLUSTER Cases

Robust Touring Cases for CLUSTER Series.



### **FX Filter Elliptical Horizontal**

**CLUSTER S1, S2**

The elliptical horizontal filter shapes the light beam horizontal with a frost effect.



### **FX Filter Elliptical Vertical**

**CLUSTER S1, S2**

The elliptical vertical filter shapes the light beam vertical with a frost effect.

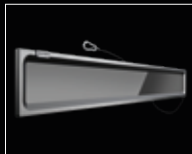

### **FX Filter Smoked Clear**

**CLUSTER S1, S2**

The Smoked Clear Filter is especially useful in TV applications, as it allows the devices to visually disappear in the stage design when switched off.



### **FX Distance Frame**

**CLUSTER S1, S2**

This distance frame creates not only an even lightbox and soft pixel mapping patterns, but also provides a 3D effect, giving lighting designers additional design options and stunning eye-candy effects.

An integrated bolt on the edge allows the safety cable of the FX Filters to loop through.



### **CLUSTER Line Array**

**CLUSTER B2, B4, S2**

This accessory set allows you to transform the fixtures into a powerful line array construct that mimics a professional PA system. The backbone is the heart of the system and offers a wide range of positive and negative angles.

Additional accessories include a fly bar and a floor bracket for vertical and floor set-ups.

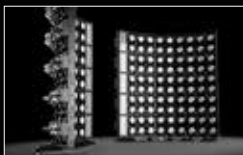

NEO Series

# NEO

FURTHER • WHITER • BRIGHTER







# NEO Series

Illuminate your world with NEO, a cutting-edge lighting fixture that combines unparalleled performance with versatility and convenience. Crafted with precision and built to withstand the elements, NEO has a certified IP65 rating, making it suitable for both indoor and outdoor use. The specially developed 8° TIR lens enables high illuminance even at long distances and guarantees homogeneous color mixing



## Magnetic 8-way barndoor

The magnetic 8-way barndoor features a new clasp, allowing quick assembly and disassembly in mere seconds with two hands. It includes a locking option for security against unauthorized removal, and a tool-assisted lock for added safety.

The 8-way barndoor of the NEO and its magnetic filters are stackable so they can be used together.

- + 24 x 40W RGBL LED's create enormous 37,000lx @ 5m (5600K calibrated)
- + The specially developed 8° TIR lens enables high illuminance even at long distances and guarantees homogeneous color mixing
- + Optional magnetic circular and elliptical filters as well as a smoked clear filter
- + CRI/Ra and TLCI of over 85 across the entire white color spectrum
- + Four controllable segments and a plethora of integrated effects
- + Near Field Communication (NFC) enables convenient and quick setup of devices via our ROXX NFC App (iOS / Android)
- + The specially developed copper heatpipe cooling system guarantees stable luminous intensity even at high ambient temperatures
- + Linear CTC control from 2000K – 10.000K
- + 2" TFT display with backlit buttons, and direct access for dimmer, CCT, gels, App control und CRMX functions
- + Integrated handles on head and yoke allow the device to be carried comfortably
- + Multiple mounting locations for creative rigging options & floor mount
- + 16-bit dimming control for smooth, perfect fades
- + Adjustable PWM frequencies up to 25kHz guarantee flicker-free camera operation



# NEO Series

## Magnetic filters & beam angles

Optional magnetic filters enable various circular and elliptical beam angles, as well as a smoked clear filter for perfect camera applications.



Smoked Clear Filter

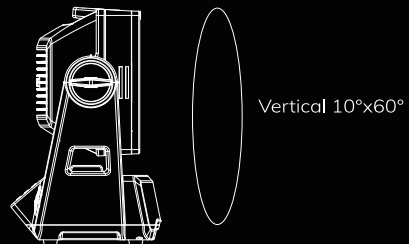
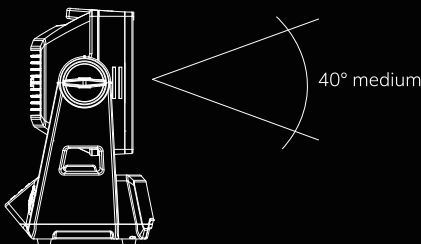
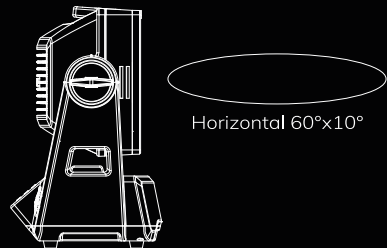
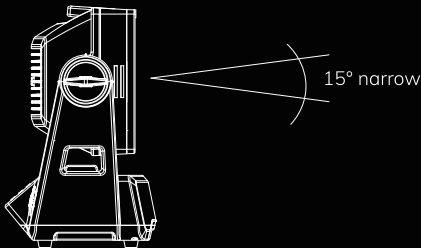
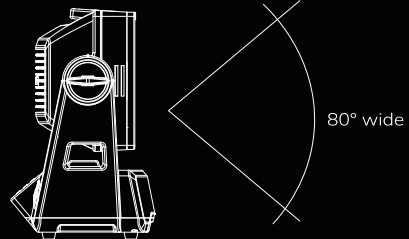
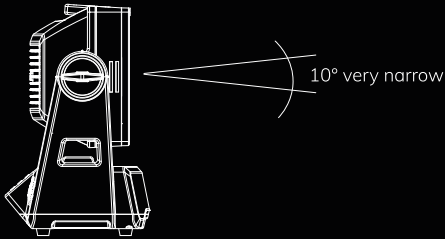
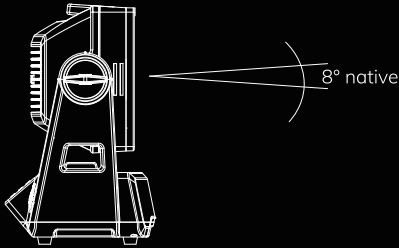



### **User-friendly 2" TFT display**

The user-friendly 2" TFT display, complemented by backlit buttons, provides direct access to dimmer, CCT, gels, app control and CRMX functions, simplifying operation for users of all levels.

In the floor application, the display is angled upwards for particularly user-friendly handling.



### **Near Field Communication (NFC)**

Experience hassle-free addressing and configuration with NEO's integrated Near Field Communication (NFC), even when fixture power is not available. This innovative feature revolutionizes your daily work processes, making light setup faster, easier, and more satisfying than ever before.



# ROXX.APP

With quick and easy connecting, direct control of the ROXX® fixtures without any additional hardware and a compatibility with all iOS mobile device, you are provided with an innovative and high-performance lighting control system.

Program and edit your lightshows comfortably and in real time whether you are preparing exhibition stands, facade lighting or an industrial event. Not only battery-operated fixtures but LED pars and floodlights too are controllable from your iOS Smartphone or tablet with the ROXX.APP. Achieving maximum benefit through minimal effort.



## Color Switching Modes

Various color modes are immediately accessible, such as RGB, HSI, linear CCT including predefined white light templates, green/magenta shift and a huge variety of preset LEE matched color filters. ROXX® color calibration ensures excellent white tones precisely on the black body curve and performs color matching across the entire range so that adjusted colors of ROXX® spotlights are reproduced precisely and homogeneously.

+ Quick and easy connecting	+ Customizable lighting scenes
+ Direct control of ROXX® fixtures without additional hardware	+ Easily adjustable brightness
+ Compatible with all iOS devices	+ Sharing
+ 1 universe / 512 DMX channels	+ Perfect overview
+ Color Switching Modes	



### Simple connecting

ROXX.APP is super simple as your mobile device communicates directly via Bluetooth with the first ROXX® fixture in the system. No external hardware as a further communication interface is needed. A direct connection prevents complicated lighting networks and ensures a comfortable usage.

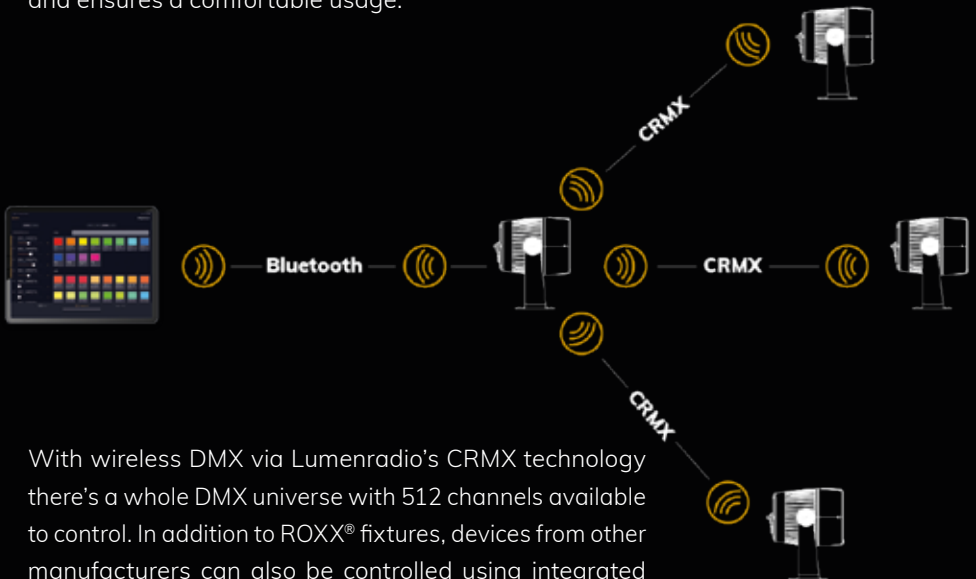

With wireless DMX via Lumenradio's CRMX technology there's a whole DMX universe with 512 channels available to control. In addition to ROXX® fixtures, devices from other manufacturers can also be controlled using integrated CRMX technology.

Get ready to  
**ROXX**<sup>®</sup>



**ROXX GmbH** | Cologne/Germany  
[www.roxxlight.com](http://www.roxxlight.com)